

DVC700 Series Controllers

DVC725 User Manual – Rev. B



www.hctcontrols.com

Index

Product Overview	3
Hints & Tips	4
Connections	5
Pin-Out.....	5
Example Configuration	6
Mating Connector Information	6
Product Specifications	7
User Interface	7
Operational Specifications	8
Communication	8
Inputs	8
Standards	9
Certifications	9
Mounting	10
Recommended Operating Parameters / Pin Functions.....	11
Diagnostic Indicators	12
Configuration	13
Getting Started.....	13
Dashboard Window	14
Configuration Window.....	15
J1939 CAN Bus Communication	19
Status Message Format	20
Message Definitions	20
Command / Profile Message Format.....	22
Module ID & PGN Map	23
Accessories	25
Order Guide	25
Contact & Locations.....	26

Product Overview

The DVC725 is a robust input expansion controller that receives 40 discreet inputs (ON / OFF) for hydraulic control systems. It is designed to be used as an input expansion module for the DVC700 series controllers or as a stand-alone input module using direct SAE J1939 communication. Up to 127 modules could be used on a single CAN bus using any number of command modules.

Each input may be individually configured as Active High or Active Low with additional filtering and toggle features.

The DVC725 must be initially configured using the Intella Program Loader Monitor (PLM) for Mac ID, Module Number, Baud Rate and CAN type.

The inputs can be configured using the PLM or any J1939 CAN capable Electronic Control Unit (ECU).



- 40 discrete input (ON / OFF) expansion module
- Can be used with any J1939 CAN capable control device
- Can be combined with DVC700 series controllers as an input expansion module for large system solutions
- For systems that require many sensor switches or safety switches
- SAE J1939 or DVC DeviceNet CAN bus communication
- Rugged and fully encapsulated
- SAE J1455 environment and load dump compliant
- IP67, 69K
- CE Certified

For the Mobile and Industrial hydraulic markets.

Hints & Tips

Hints & tips for successful application of High Country Tek's electro-hydraulic control products

ALWAYS do the following:

- Read this entire manual and product data sheets BEFORE starting.
- Isolate the controller from all other equipment BEFORE any form of welding.
- Isolate the controller from ANY form of battery charging or battery boosting.
- Be aware of the electrical & mechanical connections, and the expected reactions of the equipment.
- Operate the controller within the temperature range.
- Use the correct tools (i.e. P.C., software) etc.
- Separate High Voltage AC cables from Low Voltage DC signal and supply cables.
- Make sure power supply is CORRECT, ELECTRICALLY CLEAN, STABLE and rated for the full load.
- Make sure the controller voltage & current are compatible with the equipment!
- All unused wires / terminals should be terminated safely.
- Ensure ALL connectors have no unintended SHORT or OPEN circuits.
- Ensure ALL connectors are wired correctly, secure, locked in place and fully connected.
- Disconnect or connect wires to or from the controller only when the power supply is disconnected.
- Use adequate screening in areas of intense Radio Frequency fields.
- Ensure ALL work areas are clear of personnel before operating the controller.
- Follow and abide by local and country health & safety standards!

Software Safety

- Use the correct PLM and hardware combination.
- Cycle the power to ensure changes are accepted by the controller.
- When the PLM is first connected to a powered controller, a 'Handshake' takes place to confirm the internal software (BIOS) is compatible with the PLM. This allows the PC and the module to communicate. If an error is detected, the PLM will indicate "OFF LINE" and NOT allow communications.

Never do the following:

- Attempt to use this unit if you are unsure of electrical or hydraulic connections or expected operation.
- Operate this unit without the recommended power supply in put fuse installed as recommended power supply input fuse installed as recommended.
- Arc weld or charge batteries with this controller unit connected as damage can occur.
- Attempt to use this unit in areas where other AC or DC coils have not been fully suppressed.
- Install Amplifiers in vicinity of AC products – e.g. VFD Amplifiers, motor starters, HV fuses, etc.
- Use a power supply that is not rated for the correct required output current under full load.
- Allow wires to or from the unit to short circuit (to each other or chassis/cabinet)/.
- Attempt to use this unit in areas of intense radio Frequency (RF) without adequate screening measures.
- Disconnect or connect wires to or from this unit unless it is isolated form the power supply.
- Use this unit in temperatures that exceed specifications as operation may be affected.
- Start this unit without ensuring ALL work areas are clear from personnel.

Connections

Pin-Out

30 Pin Cinch

Pin	Function
-----	----------

A1	N/C
A2	CAN H
A3	CAN L

D1	Input 5
D2	Input 6
D3	Input 7

G1	Input 14
G2	Input 15
G3	Input 16

K1	Input 23
K2	Input 24
K3	Input 25

Pin	Function
-----	----------

B1	POWER COM
B2	+ POWER IN
B3	Input 1

E1	Input 8
E2	Input 9
E3	Input 10

H1	Input 17
H2	Input 18
H3	Input 19

Pin	Function
-----	----------

C1	Input 2
C2	Input 3
C3	Input 4

F1	Input 11
F2	Input 12
F3	Input 13

J1	Input 20
J2	Input 21
J3	Input 22

18 Pin Cinch

a1	Input 26
a2	Input 27
a3	Input 28

d1	Input 35
d2	Input 36
d3	Input 37

b1	Input 29
b2	Input 30
b3	Input 31

e1	Input 38
e2	Input 39
e3	Input 40

c1	Input 32
c2	Input 33
c3	Input 34

f1	RXD
f2	TXD
f3	POWER COM

Example Configuration

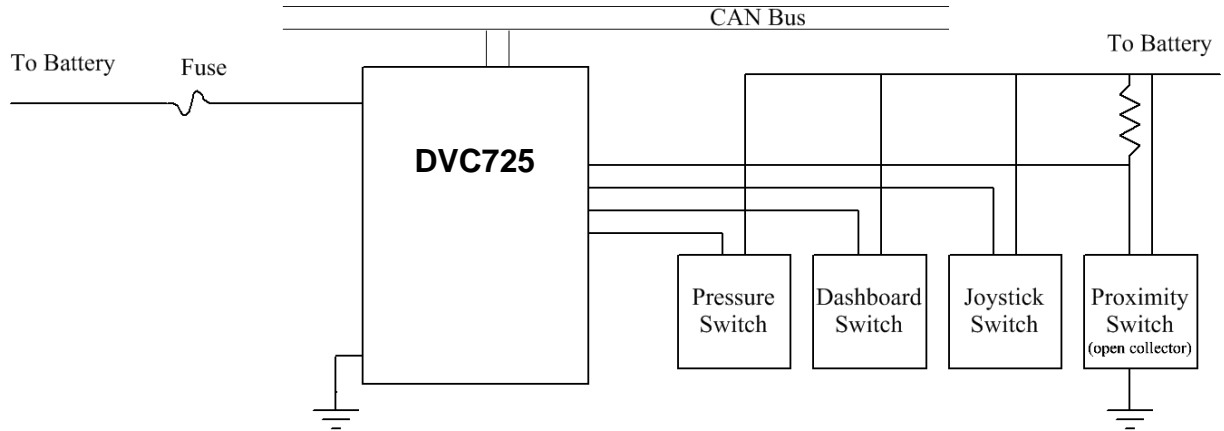

Mating Connector Information

DELPHI PACKARD MATING CONNECTOR PARTS	
Module Connector – 48 Pin	Cinch 581-01-48-011
Mating Connector – 30 Pin	15492542-B
Mating Connector – 18 Pin	15492546-B
Terminals, Female:	12103881
Cavity Plug:	12034413
Terminal Crimp Tool:	12039500
Extraction Tool:	12094429

Product Specifications

User Interface

The DVC725 is configured using HCT's free Intella® Program Loader Monitor (PLM). The PLM is used as the primary interface to specify the communication speed, type, module and MAC ID. The PLM can also be used to configure the inputs and for J1939 communication when used with other J1939 CAN capable Electronic Control Units (ECU). The PLM also contains a dashboard providing real time feedback for diagnostics and troubleshooting. The communication cable 999-10075 and adapter 108-00119 are required in order to communicate between a PC and the DVC725.

- Save and load data files
- Monitor switch status directly from a CAN capable device or display for safety messages and diagnostics
- Monitor switch inputs directly from the DVC725 controller without needing a DVC710 or DVC707 master controller
- Configure the debounce time between 0 and 10 seconds with 10 ms intervals in order to set active time limits for safety switches or to prevent false switch detection

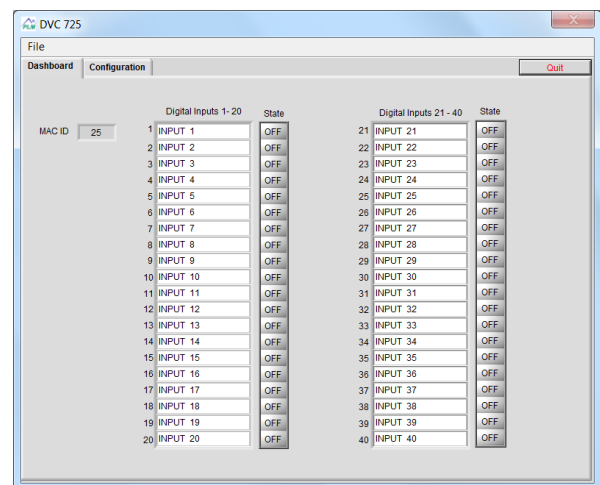

Figure 1 DVC725 PLM Dashboard Window

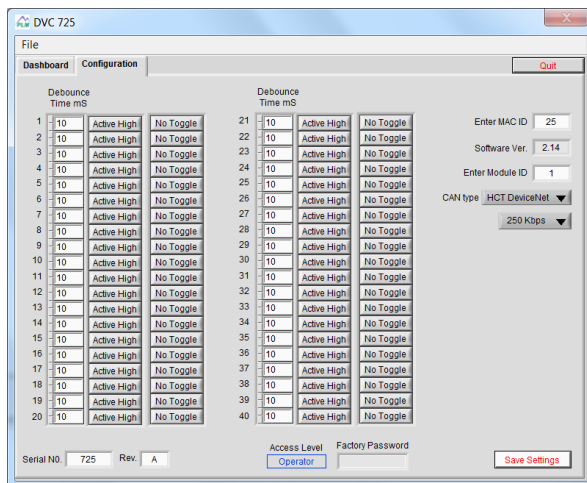

Figure 2 DVC725 PLM Configuration Window

- Select Active High or Active Low for logic ON / OFF configuration
- Select Toggle or No Toggle modes for push buttons and switch types
- Configure MAC ID, Module ID, communication rate and CAN communication types
- Configure the switch inputs directly from a CAN capable display including: debounce time, active state and toggle mode
- Compatible with High Country Tek's rugged displays (PV780 and PV450)

Operational Specifications

Supply Voltage	9-30 V _{DC} (recommended operating voltage +12 to +28 V _{DC} , absolute maximum +/- 32 V _{DC})
Supply Current	< 150 mA
Operating Temperature	-40 to +85°C
Storage Temperature	-40 to +100°C
Weight	1.34 lbs (0.61 kg)
Dimensions	L: 5.50 in (140 mm) x W: 4.70 in (119 mm) x H: 1.65in (42 mm)
Enclosure	Solid potted, industry standard Deutsch enclosure with automotive connectors
NEMA / IP Rating	NEMA 6P / IP67, 69K

Communication

CAN	2.0B (maximum voltage +/-14V _{DC})
Baud rates	125 kb/s, 250kb/s, 500kb/s, 1Mb/s, software configurable
Protocol	SAE J1939, HCT DeviceNet
Default baud rate	250kb/s
Serial Interface	RS232 (maximum voltage Rxd,RTS = +/-15V _{DC} Txd = +/-8 V _{DC})

Inputs

Digital (Qty 40)	Discrete high/low, software configurable
Input Range	0 to +Supply, (Impedance Z > 100 KΩ)
Debounce Time	0 to 10 seconds, 10ms intervals, software configurable

NOTE: 1) Maximum voltage on any input pin +/-32 V_{DC}

Standards

Environmental	SAE J1455	Immunity	89/336/EEC, EN 61000-6-2
Temperature	Section 4.1.3.2	ESD	EN 61000-4-2
Salt Spray	Section 4.3.3.1	EMC	EN 61000-4-3
Steam Cleaning & Pressure Washing	Section 4.5.3.2	EMC	EN 61000-4-4
Vibration	Section 4.10.4.2	RF	EN 61000-4-6
Shock	Section 4.11.3.4	Emissions	89/336/EEC, EN 61000-6-4
Load Dump	Section 4.13.2.2.1.a		EN 55011

Certifications

CE Mark

Mounting

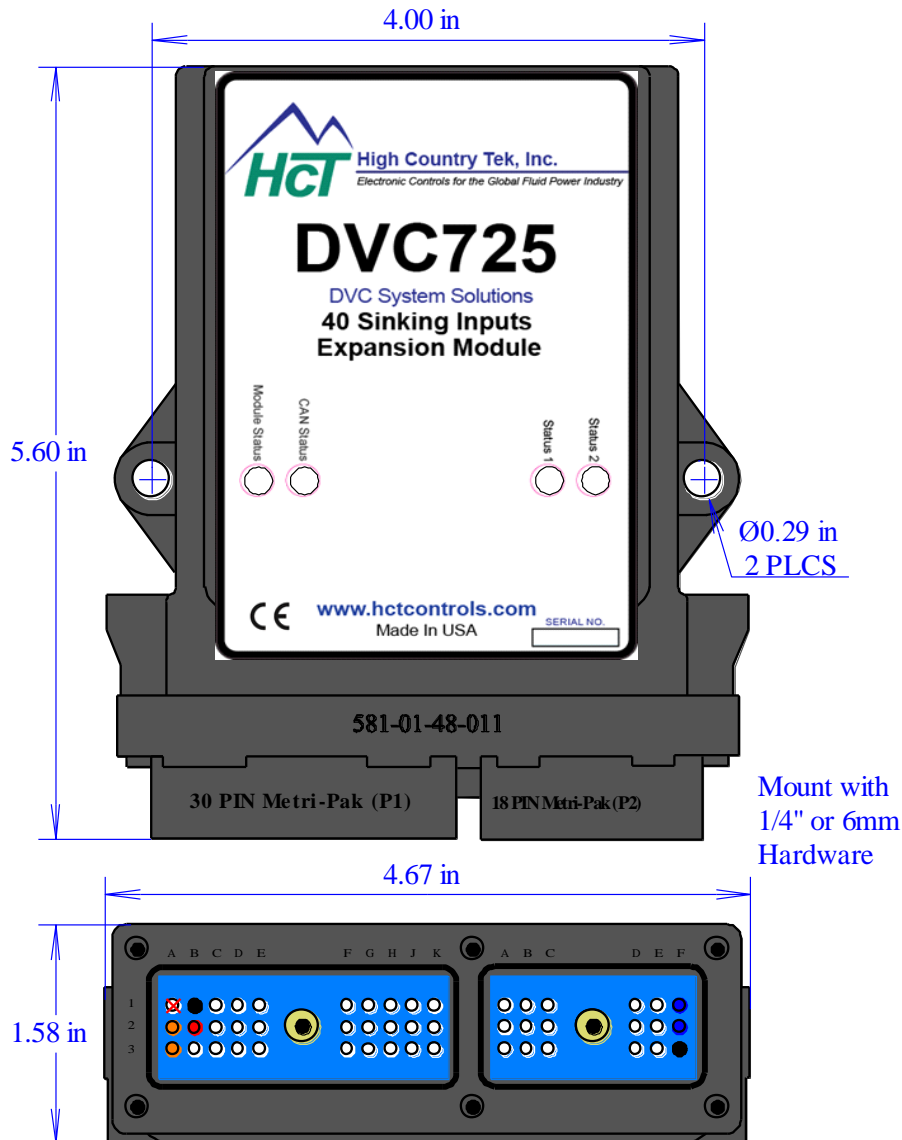

Figure 3 DVC725 dimensions

Notes:

- 1) All dimensions are in Inches (Millimeters).
- 2) Use 1/4 x 20 SAE Grade 2 bolts (M6 x 1 ISO Grade 8)
 - * Torque to 4 ft-lbs (5.4 N-m) Dry
 - * Torque to 3 ft-lbs (4.1 N-m) Oiled
- 2) Mount to a flat hard surface protected from excess heat and moving parts.
- 3) Factory recommended 18-22 AWG (1.02mm to 0.64mm) TXL, XSL, and GXL automotive grade wire
- 4) Each Power pin used must be individually fused with an ATO 5, AGC 5 or smaller fuse

Recommended Operating Parameters / Pin Functions

Uppercase letters designates the 30-pin connector.

Lowercase letters designates the 18-pin connector.

Pin	Name	Function/Features	Range
B2	Power In (Note: 1)	Positive Power Supply Input	+12V _{DC} to +28V _{DC}
B1, F3	Power Common (Note: 1)	Return for Power Supply or Signal Com	0 Volts (GND)
B3 – K3 And a1 – e3	Digital Inputs (Note: 2)	On / Off.	0 to +Supply

- Notes:**
1. Maximum continuous current allowed on any single connector Pin = 5 Amps
 2. Input impedance, 100 K Ω with respect to Ground (0V_{DC})

Diagnostic Indicators

Module Status	
LED STATE	MEANING
Off	There is no power applied to the module.
On GREEN	The module is operating in a normal condition.
Flashing GREEN	Device is in standby state. May need servicing.
On RED	Module has an unrecoverable fault.
Flashing RED	Low Supply Voltage.
CAN Status	
On GREEN	Communication established with another Master Controller
Flashing GREEN	Waiting to establish communication with the Master Controller
On RED	J1939 Communications are in a timed out state
Flashing RED	The DVC Devicenet communication is in a timed-out state
Status 1	
One GREEN Flash	An input has changed its state
On GREEN	Normal operation
Status 2	
On GREEN	Normal operation

Configuration

Getting Started

For programming the DVC725 for use with the DVC707 or DVC710 master controllers, please refer to document number, 021-00163 DVC710 Family System and Programming Guide. Programmable features of the DVC725 for use as a standalone module on a J1939 CAN bus is explained below. Regardless of the type of system that the DVC725 is installed on, the following parameters are set using the Intella® Programming Loader Monitor (PLM) communicating through the modules serial port using communication cable 999-10075 and adapter 108-00119.

- Module Number
- MAC ID
- Module Baud Rate
- CAN bus Type

When used as a standalone module on a J1939 CAN bus the following parameters may be configured by using either the PLM or J1939 communication protocols:

- Debounce Time mS
- Active High or Active Low
- Toggle or No Toggle

Module Status and Serial Number may all be viewed through the Intella® Programming Loader Monitor.

The DVC725 must be powered up, indicated by the Module Status LED, to communicate with the module. Download the PLM software from HCT's website here:

<http://www.hctcontrols.com/software/index.htm>

Access direct communication through the RS232 port using the communication cable (outlined in the Order Guide). Once the PLM program is initialized, a Start-Up screen will appear indicating whether communication was successful. When communication is detected, the DVC725 PLM will automatically open.

Dashboard Window

The main Dashboard tab on the DVC725's PLM screen displays the current status of all 40 inputs at the same time. The modules MAC ID is also displayed here. The drop down menu for file operations allows the user to read and save data files containing the modules profile information.

Input State

Digital or Discreet inputs have two states, On and Off. Digital inputs are set and reset by the opening or closing of a switch during system operation. The activation of a switch presents a voltage to the DVC725's digital input pin. The DVC725's hardware and software interpret the voltage and convert it to a true or false value that is reported to the DVC Master module or other ECUs on the CAN Bus.

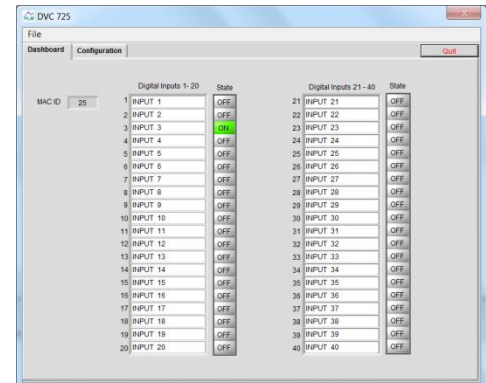

Figure 4 DVC725 PLM Dashboard Window

File Menu

Available in the Intella® Programming Loader Monitor, the File Menu is used to Save / Load configuration files between DVC745 Modules.

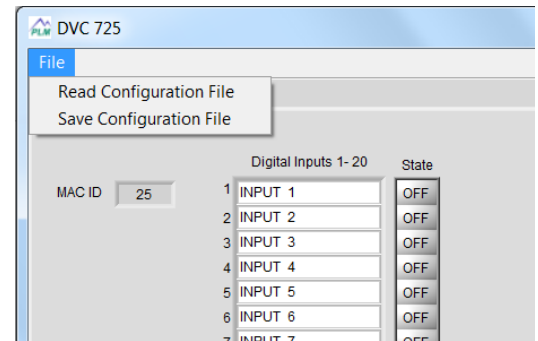
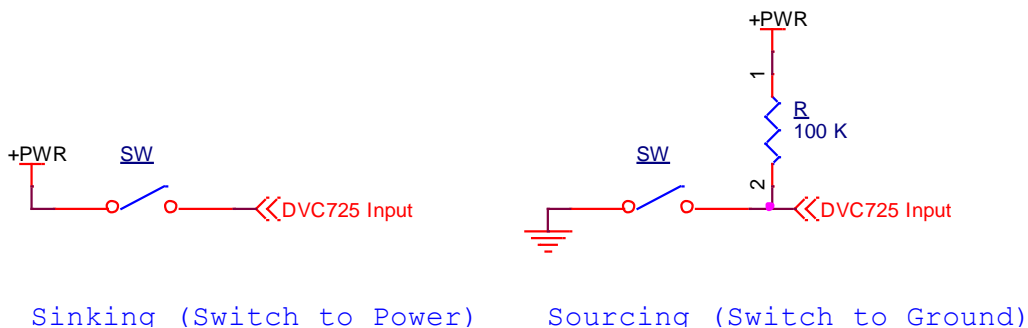

Figure 5 DVC725 PLM File Menu

The DVC725's Digital Inputs hardware provides a path to GND through a 32KΩ resistor and must be pulled high to change states. If the user wishes to operate the input by using a switch to ground instead of power, an external pull up resistor may be used with the systems positive power supply as shown below (Sourcing). Each digital input may be configured as either Active High or Active Low. When configured as Active High, the input will report as False when open or at zero Volts and True when high or at >2.5 Volts. When configured as Active Low, the input will report as True when open or at zero Volts and False when high or at >2.5 Volts.



Configuration Window

The Configuration tab is where the user can setup each individual input's Debounce time, the modules Mode, Mac ID, Module Number, CAN Type and Baud Rate. Simply select or enter the desired values and select the Save Settings button to send the new settings to the module. Profile changes made here are automatically saved in the modules permanent memory. Password operation beyond Operator is reserved for factory use only.

Debounce Time

Configure the debounce time between 0 and 10 seconds with 10 mS intervals in order to set active time limits for safety switches or to prevent false switch detection. Maximum range is 9990 mS.

Transient voltage spikes that can be felt by the DVC725's inputs are caused by many things in the system such as: inductive switching, alternators, motors and engine ignition systems. The Debounce feature allows the user to filter out these transient voltages seen on the digital input wires. When the DVC725 circuitry senses a voltage change it begins counting down the Debounce timer for that input. If at the end of the timer the voltage on the input is still in range, the input is then considered valid and the DVC725 will change the reported state if the input as required. If not, the input state remains the same and the cycle begins again at the next input voltage change.

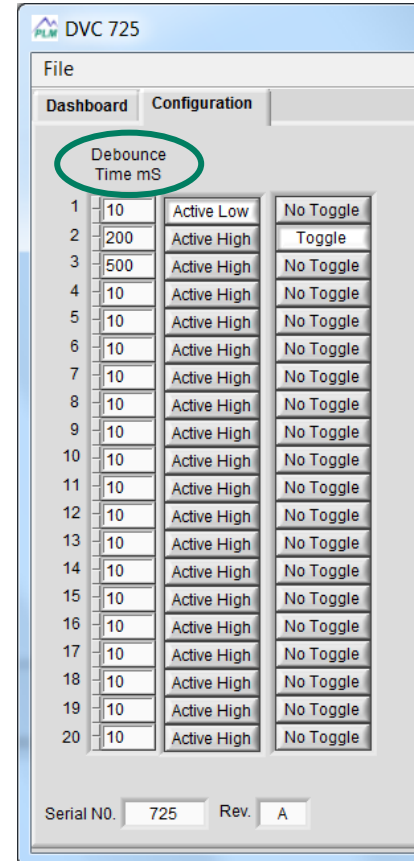
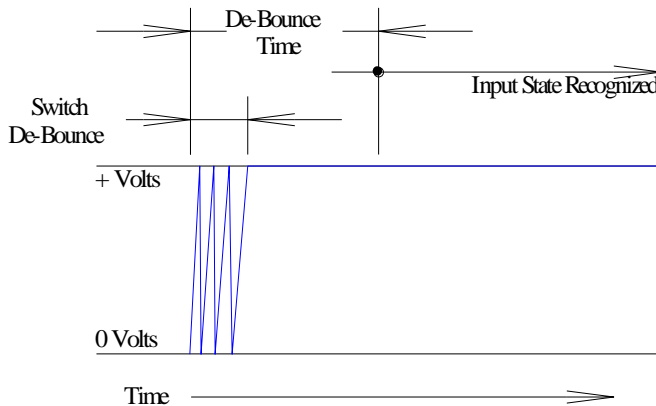

Figure 6 DVC725 PLM Configuration Window

Active High / Active Low (Input Polarity)

Select Active High or Active Low for logic ON / OFF configuration. When Active High is selected, the variable is true when the input is high (+ Voltage). When Active Low is selected, the variable is true when the input is low (ground or floating).

Toggle

Select Toggle or No Toggle modes for push buttons and switch types. The Toggle feature causes the module to latch the input to its complimentary output state (ON or OFF) for each valid rising or falling pulse with respect to the Polarity setting. A valid pulse is a pulse with a period that satisfies the debounce time.

With Toggle selected the output will turn ON when a push button is depressed and released once and will remain ON until the push button is depressed and released a second time. With No Toggle selected, the output will turn on when the button is depressed but turn off when the button is released. No Toggle mode is most common when using ON / OFF switches.

Serial Number

Displays the modules Serial Number (display only).

Revision Number

Displays the modules Hardware Revision Number (display only).

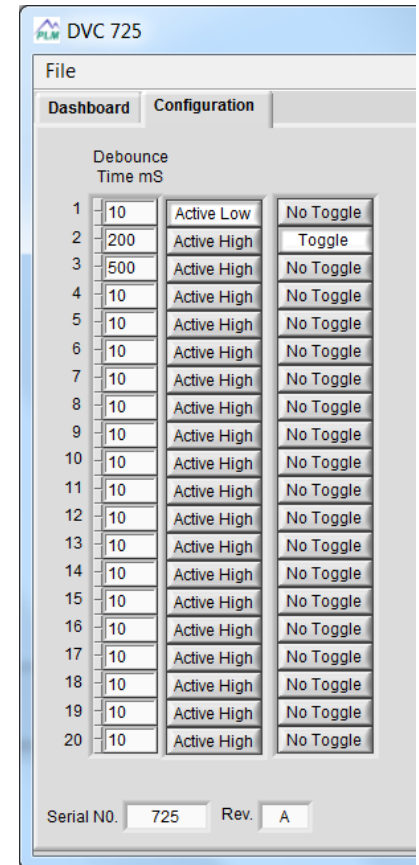

Figure 7 DVC725 PLM Configuration Window

MAC ID

The Media Access Control Address that the module uses to communicate to a DVC Master Module when in DVC DeviceNet mode.

Range: 1 to 63

Software Version

Version of the firmware installed into the module (display only).

Module ID

The modules Identification Number used when in J1939 Mode to determine the PGN numbers employed for CAN communication. (Must be unique with respect to each HCT module on the bus.)

Range: 1 to 127

CAN Type

Pull down menu that allows the user to select between J1939 mode and DVC DeviceNet Mode.

Baud Rate

Pull down menu that allows the user to select between available Baud Rates.

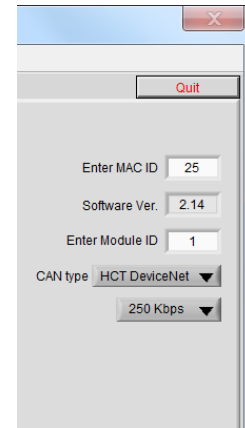

Figure 8 DVC725 PLM Configuration tab

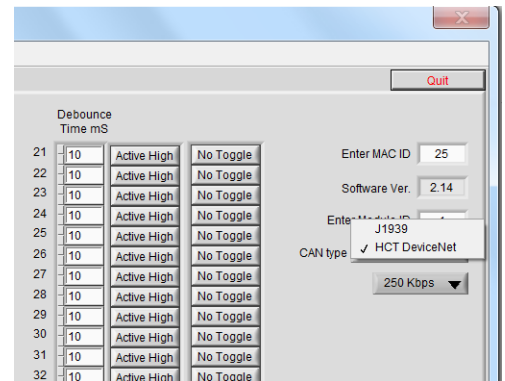

Figure 9 DVC725 CAN Type

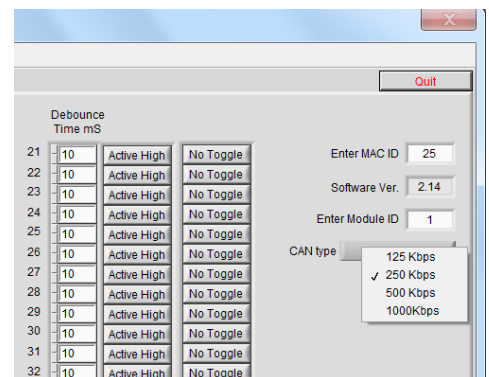

Figure 10 DVC725 Baud Rate

Save Settings

When making changes to the modules configuration through the Intella® Programming Loader Monitor, Select “Save Settings” to write the changes to the module.

To access previously saved settings, use the file drop down menu and select “Read Configuration File”.

Access Level

Displays the modules current authorized password level (display only).

Factory Password

For factory use only.

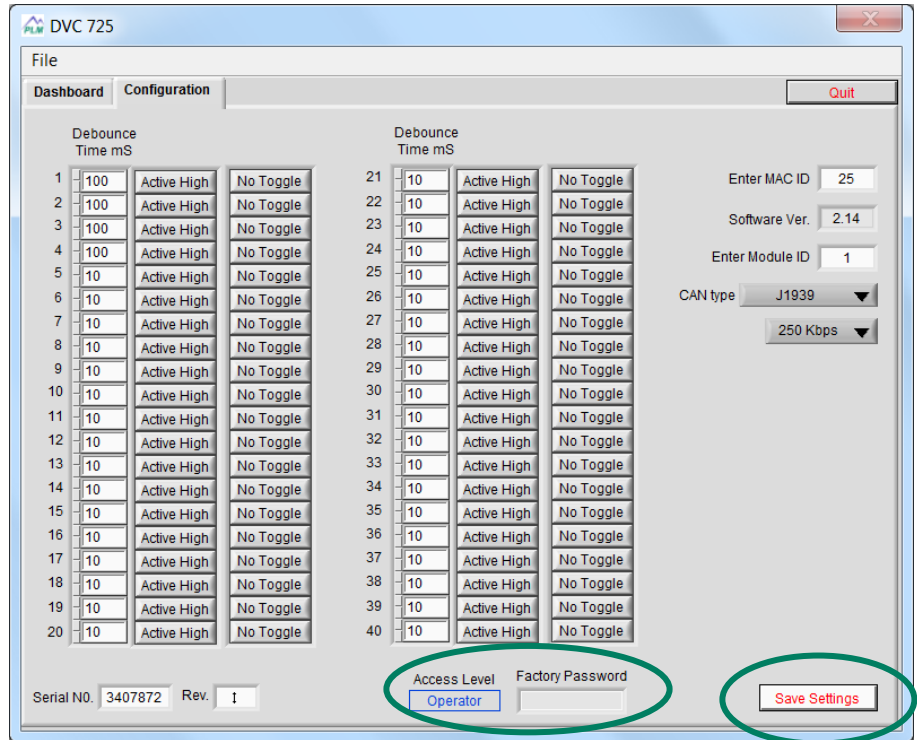

Figure 11 DVC725 PLM Configuration tab

J1939 CAN Bus Communication

The DVC725 may be installed directly on a J1939 CAN bus and operate without the need for a DVC710/707 Master module using the following message format. When in J1939 Mode, the DVC725 will automatically broadcast its status on the CAN bus using a predefined PGN determined by the Module number assigned to the input module.

The DVC725 transmits and receives all J1939 messages using Source Address 0x22 (Aux Valve Controller) only. The Modules ID number determines which PGN Numbers the module will transmit and receive on the J1939 Bus. It sets the PDU Specific (PS) part of the message header for the Configuration Message that the unit will accept when being configured over the J1939 Bus. For example, a unit with the Module ID of 1 would accept PGN: 0xFF01 SA: 0x22 as a command input. Using this format, the user may command up to 127 separate expansion modules on a single Bus using any number of master controllers. Valid module ID numbers are 1 through 127.

The PGN numbers 0xFF01 through 0xFF7F are used as Configuration Messages for the DVC725. PGN numbers 0xFF00 and 0xFF80 are reserved for special functions. PGN numbers 0xFF81 through 0xFFFF are used as the complementary Status Messages transmitted by the DVC725. The user can calculate the PGN that the Module will transmit as its Status Message by adding 0x80 to the Module ID. For example, a unit with a module ID of 61 would accept PGN 0xFF3D as a command message and would transmit PGN 0xFFBD as its Status Message, $0xFF3D + 0x80 = 0xFFBD$. A list of Module IDs, Command Message PGNs and Status Message PGNs is listed below.

The DVC725 will transmit its state message whenever there is a state change on one of the inputs or at least once every 1000mS. The DVC725 will transmit a Profile Acknowledgment message each time that it receives and processes a valid profile message. The Profile Acknowledgment message will contain the exact same data field that was received in the profile message and may be used by the controlling ECU to verify that the input was profiled correctly.

Status Message Format

Transmission Cycle Time: 1000mS or on change.
 Data Length: 8
 Data Page: 1
 PDU Format: 255
 PDU Specific: Module ID + 128 (0x80)
 Priority: 6
 Parameter Group Number: 65409 Through 65535 (FF81 Through FFFF)

<u>Start Position</u>	<u>Length</u>	<u>Parameter Name</u>
1.1	1 Byte	Multiplexer
2.1	1 Byte	Module Type
3.1	1 bit	Input 1 State
3.2	1 bit	Input 2 State
33	1 bit	Input 3 State
...
7.6	1 bit	Input 38 State
7.7	1 bit	Input 39 State
7.8	1 bit	Input 40 State

Message Definitions

Multiplexer

Data Length: 1 Bytes
 Resolution: 1 bit, 0 offset
 Data Range: 0 to 255
 Operational Range: 1 to 5
 Definitions:
 0 – Invalid
 1 – Profile Mode
 2 – Profile Acknowledgement
 3 – Reserved
 4 – Command Outputs (DVC745)
 5 – Save Profile to Permanent Memory
 6...255 – Reserved

Module Type

Data Length: 1 Byte
 Resolution: 1 bit, 0 offset
 Data Range: 0 to 255
 Operational Range: 1 to 2
 Definitions:
 1 – DVC725
 2 – DVC745

Input State

Data Length: 1 bit
Resolution: 1 bit, 0 offset
Data Range: 0 to 1
Operational Range: 0 to 1
Definitions: 0 – Input Off (False)
1 – Input On (True)

Input Index Number

Data Length: 1 Byte
Resolution: 1 bit, 0 offset
Data Range: 0 to 255
Operational Range: 1 to 40
Definitions: 1 – Input 1
2 – Input 2 ...

Debounce x10mS

Data Length: 10 bits
Resolution: 10mS / bit, 0 offset
Data Range: 0 to 1023
Operational Range: 1 to 999 (values >999 are ignored)

Active State Mode

Data Length: 1 bit
Resolution: 1 bit, 0 offset
Data Range: 0 to 1
Operational Range: 0 to 1
Definitions: 0 – Active High
1 – Active Low

Toggle Mode

Data Length: 1 bit
Resolution: 1 bit, 0 offset
Data Range: 0 to 1
Operational Range: 0 to 1
Definitions: 0 – Toggle Mode Off
1 – Toggle Mode On

Command / Profile Message Format

Transmission Repletion:	As Required	
Data Length:	8	
Data Page:	1	
PDU Format:	255	
PDU Specific:	Module ID # 1 – 127	(0x01 – 0x7F)
Priority:	N/A	
Parameter Group Number:	65281 Through 65407	(FF01 Through FF7F)

<u>Start Position</u>	<u>Length</u>	<u>Parameter Name</u>
1.1	1 Byte	Multiplexer
2.1	1 Byte	Module Type
3.1	1 Byte	Input Index Number 1 - 40
4.1	1 Byte	Not Used
5.1	10 bits	Debounce x10mS
6.3	4 bits	Not Used
6.7	1 bit	Active State Mode
6.8	1 bit	Toggle Mode
7.1	2 Bytes	Not Used

Module ID & PGN Map

Module Id	Command PGN	Status PGN
1	FF01	FF81
2	FF02	FF82
3	FF03	FF83
4	FF04	FF84
5	FF05	FF85
6	FF06	FF86
7	FF07	FF87
8	FF08	FF88
9	FF09	FF89
10	FF0A	FF8A
11	FF0B	FF8B
12	FF0C	FF8C
13	FF0D	FF8D
14	FF0E	FF8E
15	FF0F	FF8F
16	FF10	FF90
17	FF11	FF91
18	FF12	FF92
19	FF13	FF93
20	FF14	FF94
21	FF15	FF95
22	FF16	FF96
23	FF17	FF97
24	FF18	FF98
25	FF19	FF99
26	FF1A	FF9A
27	FF1B	FF9B
28	FF1C	FF9C
29	FF1D	FF9D
30	FF1E	FF9E
31	FF1F	FF9F

Module Id	Command PGN	Status PGN
32	FF20	FFA0
33	FF21	FFA1
34	FF22	FFA2
35	FF23	FFA3
36	FF24	FFA4
37	FF25	FFA5
38	FF26	FFA6
39	FF27	FFA7
40	FF28	FFA8
41	FF29	FFA9
42	FF2A	FFAA
43	FF2B	FFAB
44	FF2C	FFAC
45	FF2D	FFAD
46	FF2E	FFAE
47	FF2F	FFAF
48	FF30	FFB0
49	FF31	FFB1
50	FF32	FFB2
51	FF33	FFB3
52	FF34	FFB4
53	FF35	FFB5
54	FF36	FFB6
55	FF37	FFB7
56	FF38	FFB8
57	FF39	FFB9
58	FF3A	FFBA
59	FF3B	FFBB
60	FF3C	FFBC
61	FF3D	FFBD
62	FF3E	FFBE

Module Id	Command PGN	Status PGN
63	FF3F	FFBF
64	FF40	FFC0
65	FF41	FFC1
66	FF42	FFC2
67	FF43	FFC3
68	FF44	FFC4
69	FF45	FFC5
70	FF46	FFC6
71	FF47	FFC7
72	FF48	FFC8
73	FF49	FFC9
74	FF4A	FFCA
75	FF4B	FFCB
76	FF4C	FFCC
77	FF4D	FFCD
78	FF4E	FFCE
79	FF4F	FFCF
80	FF50	FFD0
81	FF51	FFD1
82	FF52	FFD2
83	FF53	FFD3
84	FF54	FFD4
85	FF55	FFD5
86	FF56	FFD6
87	FF57	FFD7
88	FF58	FFD8
89	FF59	FFD9
90	FF5A	FFDA
91	FF5B	FFDB
92	FF5C	FFDC
93	FF5D	FFDD

Module Id	Command PGN	Status PGN
94	FF5E	FFDE
95	FF5F	FFDF
96	FF60	FFE0
97	FF61	FFE1
98	FF62	FFE2
99	FF63	FFE3
100	FF64	FFE4
101	FF65	FFE5
102	FF66	FFE6
103	FF67	FFE7
104	FF68	FFE8
105	FF69	FFE9

Module Id	Command PGN	Status PGN
106	FF6A	FFEA
107	FF6B	FFEB
108	FF6C	FFEC
109	FF6D	FFED
110	FF6E	FFEE
111	FF6F	FFEF
112	FF70	FFF0
113	FF71	FFF1
114	FF72	FFF2
115	FF73	FFF3
116	FF74	FFF4
117	FF75	FFF5

Module Id	Command PGN	Status PGN
118	FF76	FFF6
119	FF77	FFF7
120	FF78	FFF8
121	FF79	FFF9
122	FF7A	FFFA
123	FF7B	FFFB
124	FF7C	FFFC
125	FF7D	FFFD
126	FF7E	FFFE
127	FF7F	FFFF

Accessories

Order Guide

Part Number	Description
DVC725	40 digital ON / OFF input expansion module, 1x CAN port
999-10075	Communications Cable, multi-controller, 4-way to PC (RS232), 2m length, auto-grade
108-00119	Adapter, USB to RS232, use with 999-10075 assembly, only required if PC has no RS3232 'D' ports
999-10076	Serial port adapter for program updates, 4 wires
999-10316	DVC725, 48 pin connector kit with 1x CANbus (Deutsch) connector shell + pins, and serial port adapter 999-10076, assembly required
999-10312	DVC725, 48 pin prototype harness with 1x CANbus (Deutsch), 3m length, auto grade with serial port adapter 999-10076

Contact & Locations

HCT Headquarters
208 Gold Flat Court
Nevada City, CA 95949
U.S.A.
Phone: 530.265.3236

Sun Hydraulics Corporation Headquarters
1500 West University Parkway
Sarasota, FL 34243 U.S.A.
Phone: 941.362.1200

ONE RELIABLE SOURCE ENDLESS SOLUTIONS



Sun Hydraulics Limited
Wheler Road
Coventry CV3 4LA
England
Ph: +44-2476-217-400

Sun Hydraulik GmbH.
Brüsseler Allee 2
D-41812 Erkelenz
Germany
Ph: +49-2431-8091-0

Sun Hydraulics Corporation
Parc Innolin
6 Rue du Golf
33700 Merignac
France
Ph: +33-673063371

Sun Hydraulics Korea Corp.
92 Hogupo-ro
Namdong-gu
Incheon 405-818
Korea
Ph: +82-32-813-1350

Sun Hydraulics China Co. Ltd
Hong Kong New World Tower
47th Floor
300, Huaihai Zhong Road
Shanghai 200021
P.R. China
Ph: +86-21-5116-2862

Sun Hydraulics (India)
No.48 'Regent Prime'
Unit No. 306, Level 3
Whitefield Main Road, Whitefield
Bangalore – 560 066
India
Ph: +0091-80-28456325