

# The Murphy™ EVS Electronic Vibration Switch

## *Installation and Operations Manual*

---

00-02-0597  
04-25-06  
Section 20

In order to consistently bring you the highest quality, full featured products, we reserve the right to change our specifications and designs at any time. The latest version of this manual can be found at [www.fwmurphy.com](http://www.fwmurphy.com).

**Warranty** A limited warranty on materials and workmanship for one year is given with this FW Murphy product. A copy of the warranty may be viewed or printed by going to [www.fwmurphy.com/support/warranty.htm](http://www.fwmurphy.com/support/warranty.htm)



Please read the following information before installing the EVS.

- This installation information is intended for all EVS models. A visual inspection of this product before installation for any damage during shipping is recommended.
- Disconnect all power and be sure machine is inoperative before beginning installation.
- Installation is to be done only by qualified technician according to the National Electrical Code.
- Observe all Warnings and Cautions at each section in these instructions.
- Please contact FW MURPHY immediately if you have any questions.

FW MURPHY has made efforts to ensure the reliability of the Electronic Vibration Switch (EVS) and to recommend safe usage practices in system applications. Please note that in any application, operations and device failures can occur. These failures may result in full control outputs or other outputs which may cause damage to or unsafe conditions in the equipment or process connected to the EVS.

Good engineering practices, electrical codes, and insurance regulations require that you use independent external protective devices to prevent potentially dangerous or unsafe conditions. Assume that the Murphy EVS system can fail with outputs full on, outputs full off, or that other unexpected conditions can occur.

## Table of Contents

<b>Product Information</b> .....	<b>1</b>
Murphy EVS Overview .....	1
EVS Characteristic and Orientation.....	2
<b>Installation</b> .....	<b>4</b>
Mounting .....	5
Wiring.....	11
<b>Settings</b> .....	<b>16</b>
Setting the Set-point in Inches Per Second (IPS) Peak .....	16
Setting of Alarms.....	18
Vibration Limits Based on Class of Equipment Based on ISO 10816-3 .....	19
Equipment Manufacturer Recommended Settings.....	21
<b>Specifications</b> .....	<b>22</b>
Environmental .....	22
External DC Power Requirement .....	22
Sensor Accuracy / Noise .....	22
Trigger Level Feature .....	22
Time Delay Feature.....	22
Output .....	22
LED Outputs.....	23
4-20mA output (option) .....	23
Reset.....	23
Approvals (applied for) .....	23

**(THIS PAGE INTENTIONALLY LEFT BLANK)**

## Product Information

### Murphy EVS Overview

---

The Murphy Electronic Vibration Switch (EVS) protects against equipment failure by monitoring velocity-based vibration levels and providing an early warning or shutdown when abnormal vibration is detected. The EVS can be connected to Murphy's TTD™ annunciator, Centurion™ or Millennium™ controllers for increased functionality.

**NOTE:** The Murphy EVS complements Murphy's VS2™ shock and excessive vibration switch, which is designed to detect an abnormal shock due to equipment failure and to shutdown other equipment in a system to prevent further damage.

### Features

- Piezoelectric-crystal internal sensor with built-in microelectronics for reduced noise sensitivity
- Electronically integrated output signal that measures and trips on velocity (ips peak)
- Adjustable calibrated set-point controls
- Shutdown setpoint measured in velocity (ips peak)
- Optional 4-20 mA output for continuous monitoring capability
- Solid-state outputs for setpoint trip
- Adjustable time delay to prevent false tripping on high-vibration start-ups or non-repetitive transient events
- Self-test and calibration

### Applications

The Murphy EVS can be used on any equipment where abnormal vibration could lead to equipment damage, including:

- Cooling fans
- Engines
- Pumps
- Compressors
- Gear boxes
- Motors
- Generator sets

The Murphy EVS can monitor and alert the operator of abnormal vibration caused by a variety of possible factors, including:

- Imbalance
- Misalignments
- Worn sleeve bearings
- Broken tie down bolts
- Worn ball or roller bearings
- Gear mesh
- Blade pass frequencies
- Detonation
- Broken parts

Upon detection of abnormal vibration, the operator can decide if there is an obvious problem or if additional troubleshooting is needed. A vibration spectrum analysis can be performed to determine the exact source of abnormal vibrations.

## EVS Characteristic and Orientation

### LED Indicators

**Red LED** Illuminates during alarm activation, flashing twice per second for five minutes or until Reset is actuated. After five minutes, it will flash once every six seconds until Reset is actuated or vibration level returns below set point (in unlatched configuration).

**Green LED** Flashes once every six seconds to indicate unit is powered and operational. When monitoring battery power, the power LED will turn from green to yellow and flash every six seconds when battery needs to be replaced.

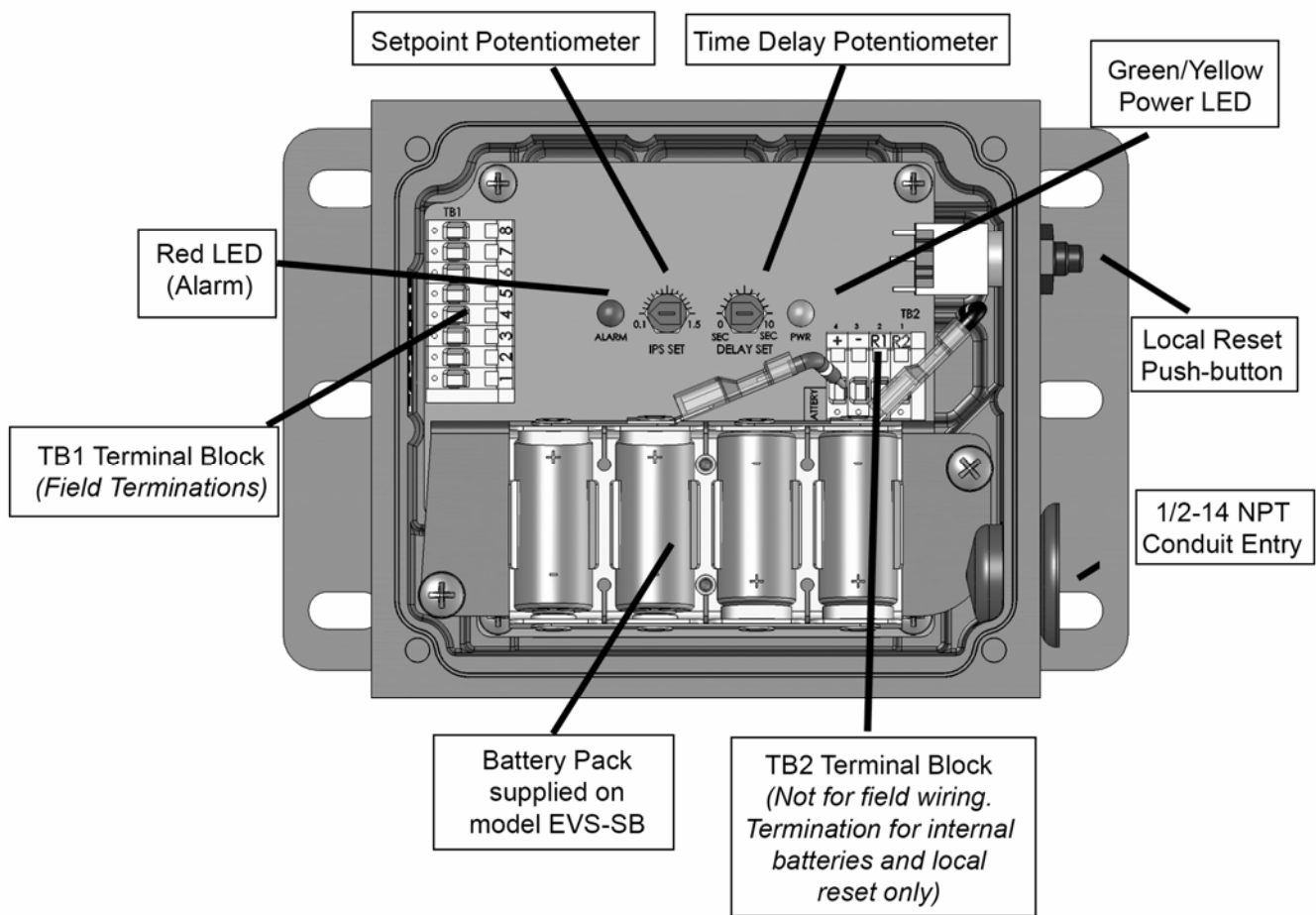


Figure 1 – Inside view of Murphy EVS components

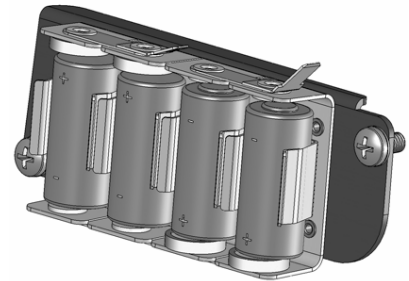
## Replacement Parts

- 20-00-0300** Replacement Batteries (4-pack)
- 20-00-0378** Gasket Kit (weatherproof boot, cover gasket)
- 20-00-0377** Cover Kit

## Battery Powered Unit

When the battery pack is used, the system will monitor the battery voltage level. Life expectancy of the battery pack is approximately 1.2 – 1.5 years in normal operation. Normal battery voltage is above 6.4 VDC. If the voltage drops below 6.4 VDC, the Green LED power indicator will turn to yellow and continue to flash every six seconds indicating that the battery pack needs to be replaced. Should the battery voltage drop below 5 VDC, the unit will switch to a shut-down state, changing the contact output to a fault state.

**TIP:** If the unit is allowed to remain in a fault state for an extended period of time, the battery life will greatly be shortened. If the unit will be out of operation, Murphy recommends disconnecting or removing the battery to preserve battery life.



**NOTE:** The analog option is not available on battery powered unit.

**NOTE:** The Murphy EVS switch output is activated for both alarm indication and loss of battery power.

## Latching/Non-Latching Modes

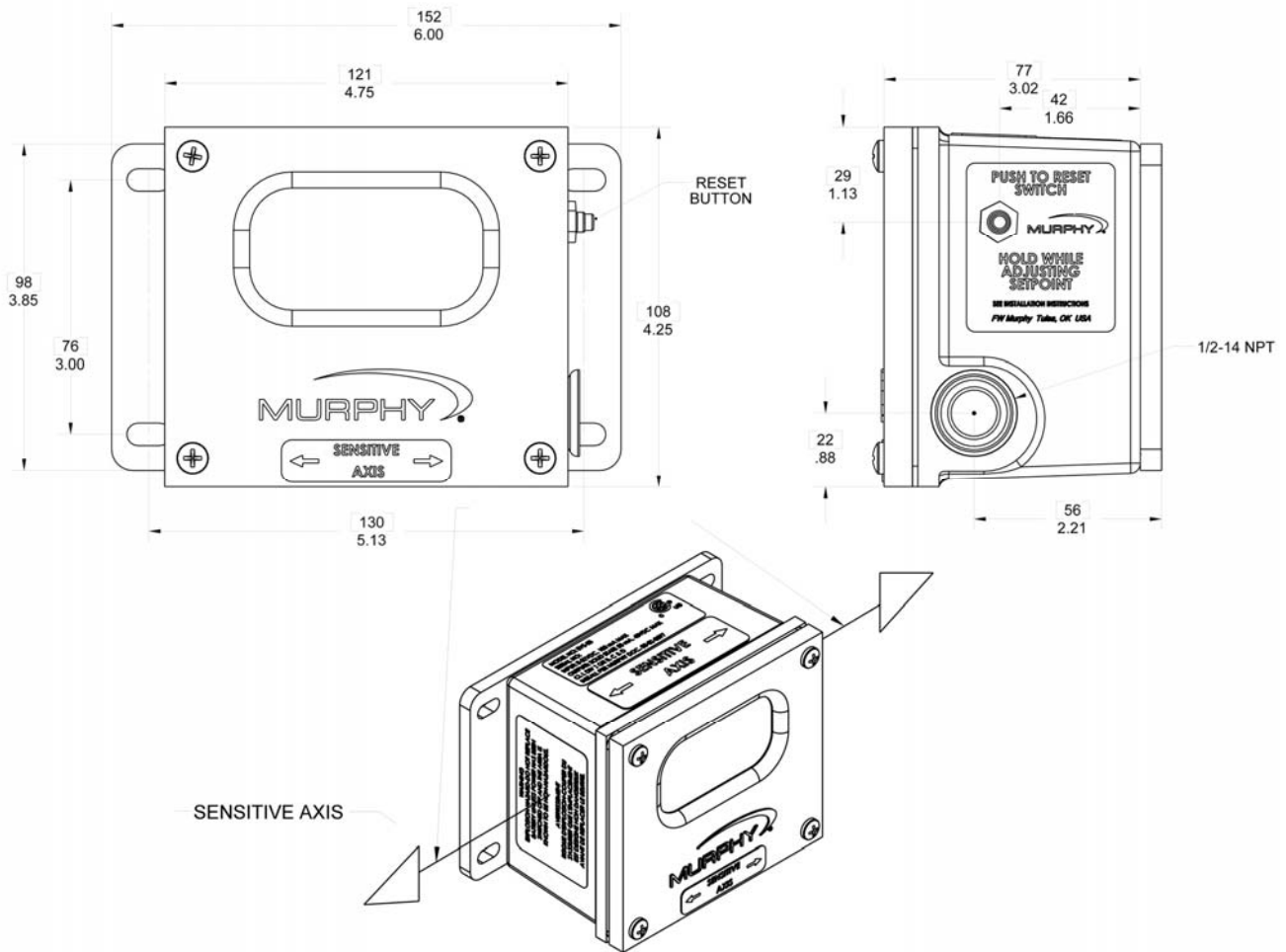
The alarm outputs can be configured to operate in a latching or non-latching mode.

- **Latching Mode (factory standard)** - When an alarm or shut-down condition is reached, the output remains in the alarm condition until it is reset. A manual reset pushbutton is mounted on the right hand side of the Murphy EVS. A remote reset dry contact can be wired into terminals 3 and 4 of TB1 terminal block.
- **Non-Latching Mode** - The output is automatically reset when the alarm condition no longer exists. In this mode, the alarm LED and output stay on while the vibration level is above setpoint. To wire, place a jumper between terminals 8 & 3 on TB1 terminal block.

## Installation

**NOTE:** The Murphy EVS must be mounted and set in accordance with the guidelines in this manual to obtain the desired and specified performance and equipment protection.

**NOTE:** Some of the steps in this section call for a slotted, narrow-head screwdriver. The recommended dimensions are .0157 thick x .098 wide blade x 2.95 in. long (0.4 x 2.5 x 75 mm). A screwdriver with these dimensions is included with each unit.



**Figure 2 – Product Dimensions and Sensitivity Axis**



## Mounting

---

The sensitive vibration “measuring” axis is parallel to the base of the unit. Always mount the unit so that the desired vibration of the equipment being monitored will occur along this axis (see “Sensitivity Axis” graphic).

In addition, the surface to which the base of the unit is attached must be flat. If the surface of the machinery housing to which you are mounting the switch is not flat, you need to grind or machine a flat surface or use a bracket according to guidelines illustrated on the following two pages. (Figures 2 and 5 thru 9)

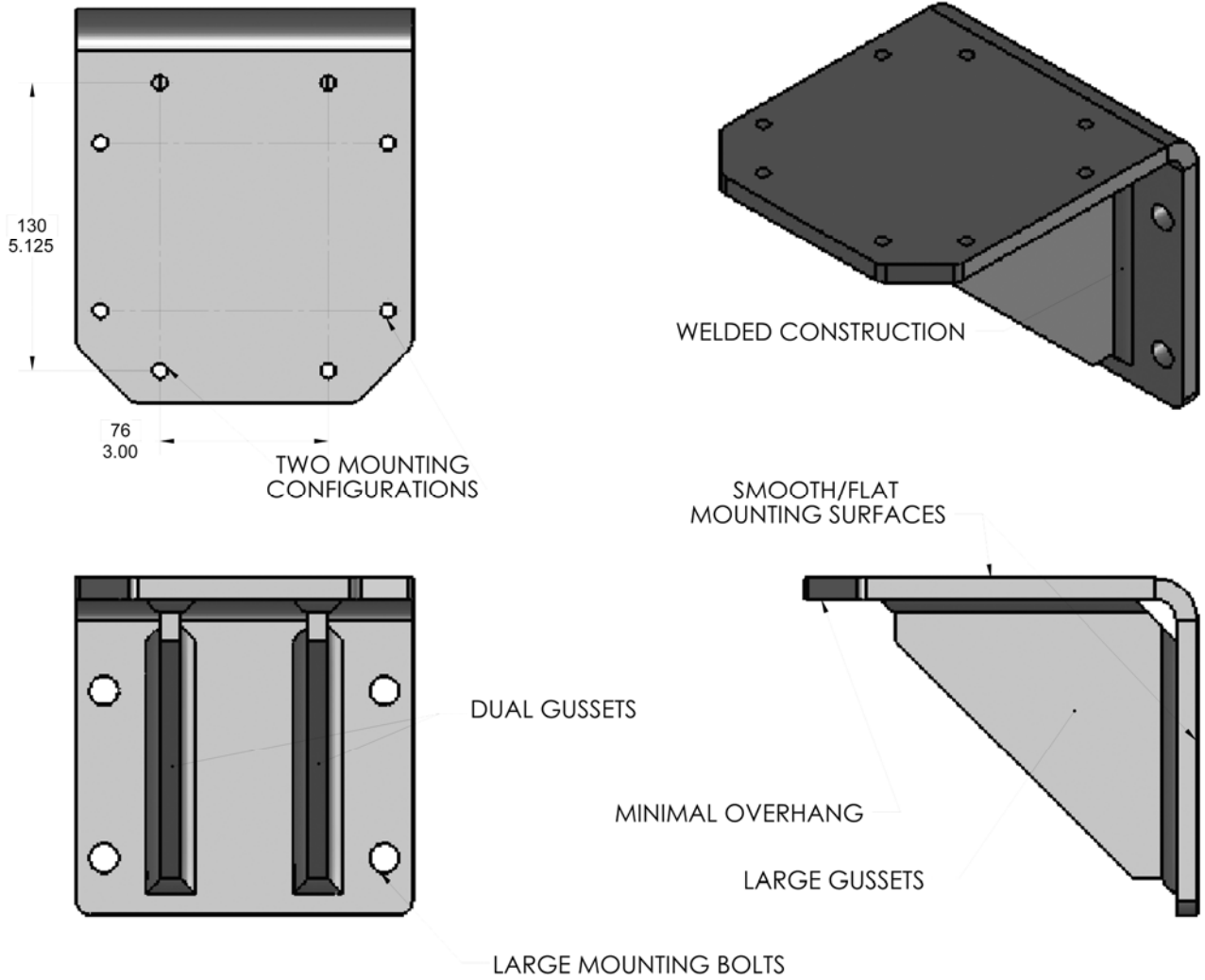
Choose or fabricate a solid (rigid) surface (on the equipment being monitored) for mounting the vibration switch. This will ensure transfer of the vibration to the vibration transducer, while not introducing other vibrations caused by mounting.

Use two (2) 1/4 x 20 Hex Bolts to the required length if you are going to bolt the switch to the surface. Murphy recommends that you apply Loctite® #242 to the bolt threads prior to installation.

### **MOUNTING AND BRACKET NOTES:**

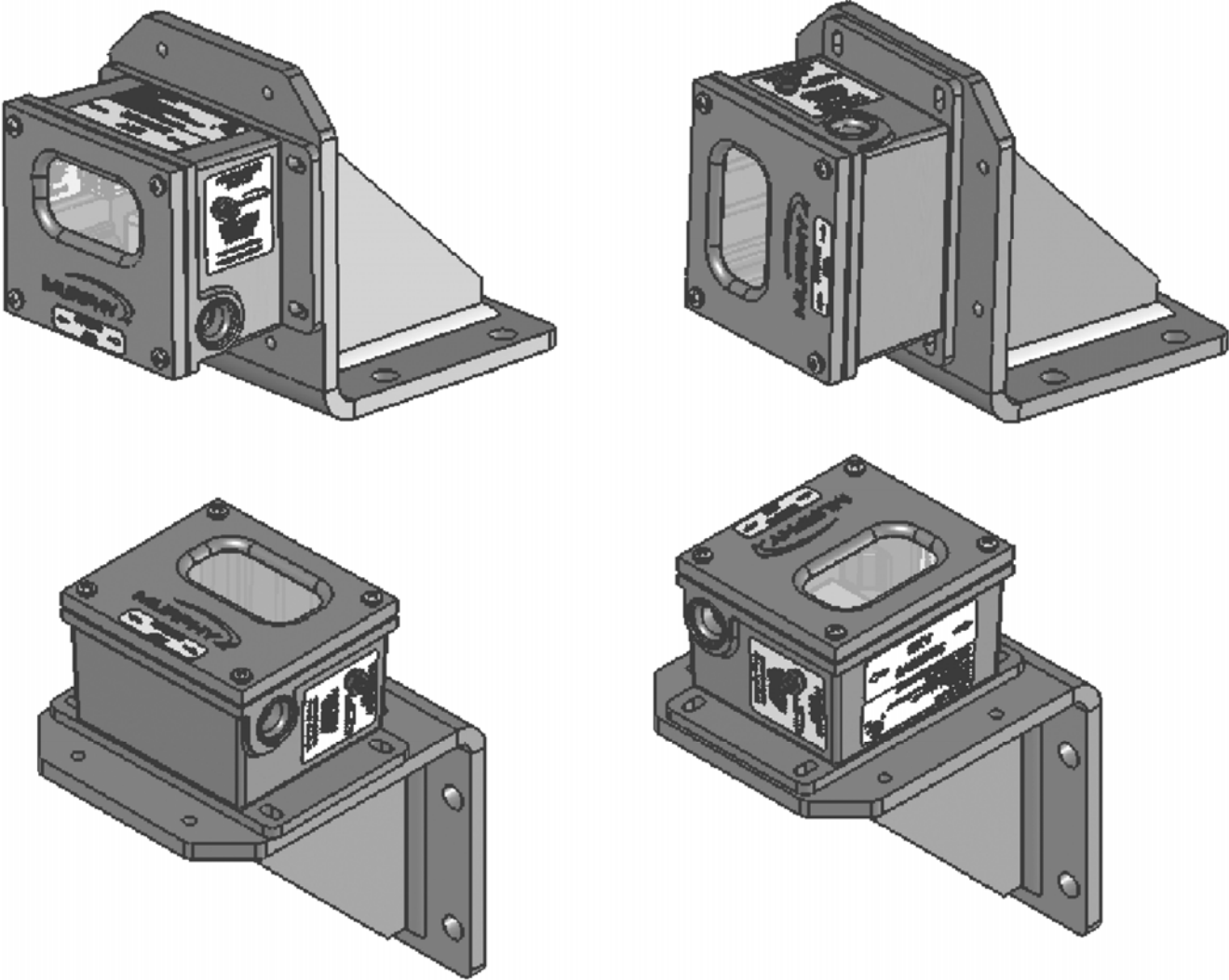
1. Unit must be mounted firmly to the monitored device via smooth flat surface.
2. Unit is to be mounted with the sensitive axis in-line with the vibration of the monitored equipment, or perpendicular to the axis of rotation. See “Typical Mounting Locations” for examples.
3. All mounting brackets should be made of welded construction and should be bolted securely to the monitored device. **DO NOT WELD BRACKET WITH MURPHY EVS INSTALLED.**
4. Recommended material and thickness for brackets is to be 3/8 inch (min) thick 6061-T6 aluminum or 3/8 inch (min) thick mild carbon steel.
5. Unit can be mounted in any orientation without affecting performance.
6. The most effective monitoring point is normally found on the bearing housing. If that point is impractical, the Murphy EVS should be mounted close to the centerline of the crankshaft, coupling, or other monitored parameter.

## Features of a Good Bracket



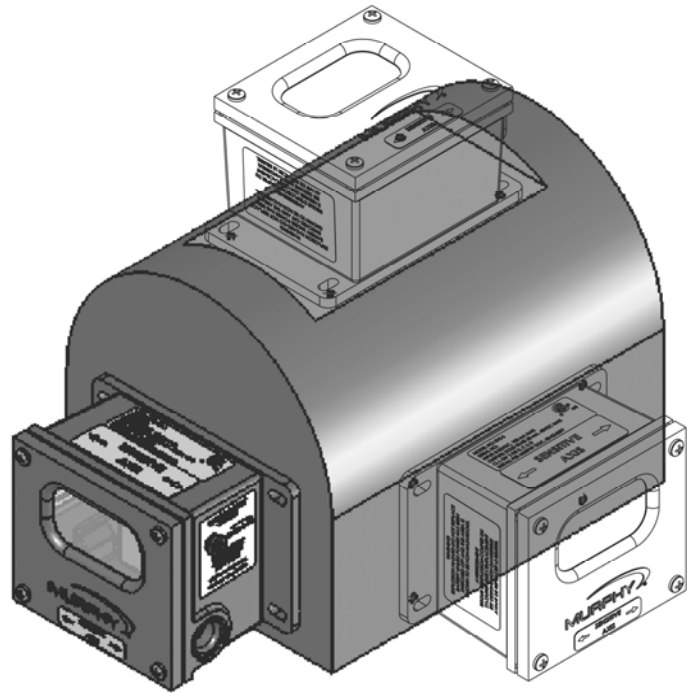
**Figure 3 – Bracket Example**

**Examples of Typical “L” Bracket Mounting**

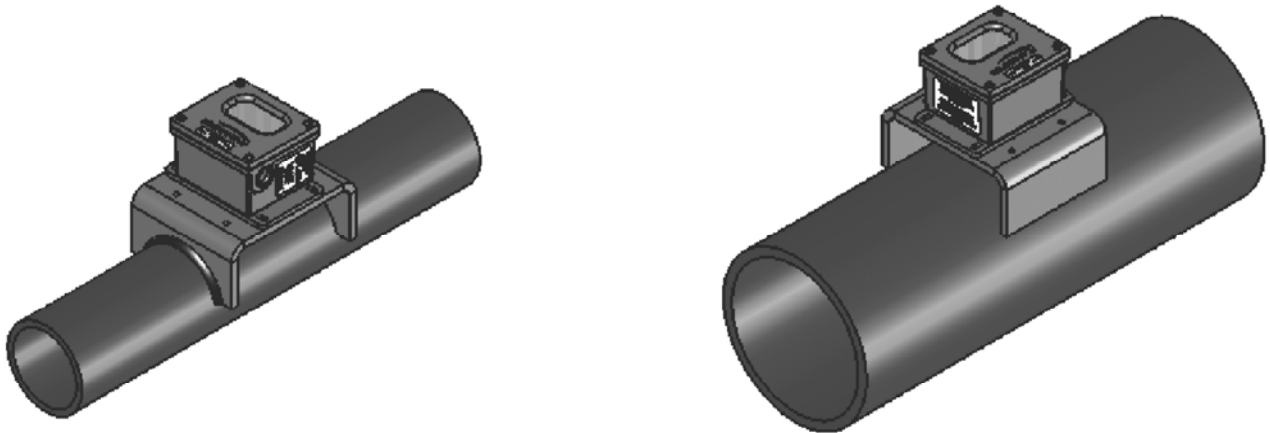


*Figure 4 – Typical “L” Bracket Mounting*

## Examples of Typical Bearing Housing or Pipe Mounting



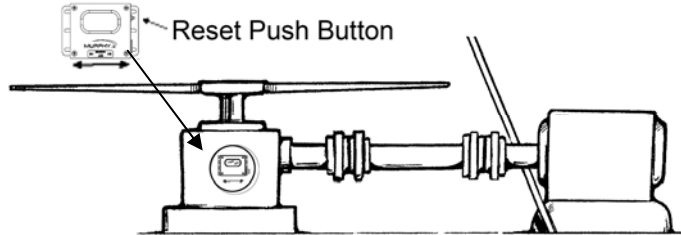
EXAMPLES OF TYPICAL BEARING HOUSING OR PIPE MOUNTING



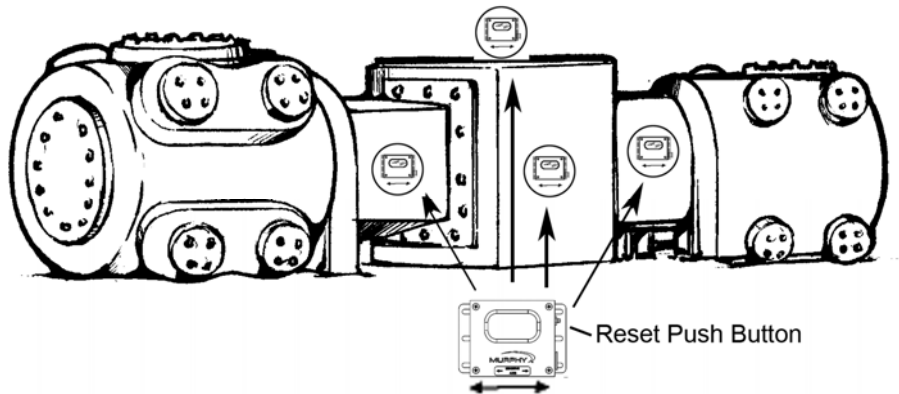
*Figure 5 – Typical Bearing Housing or Pipe Mounting*

## Typical Mounting Locations

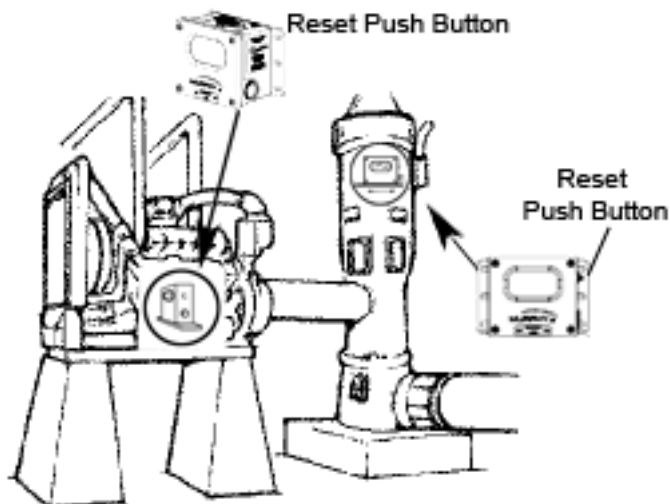
**NOTE:** These are typical mounting locations for best operation. Other mountings are possible.



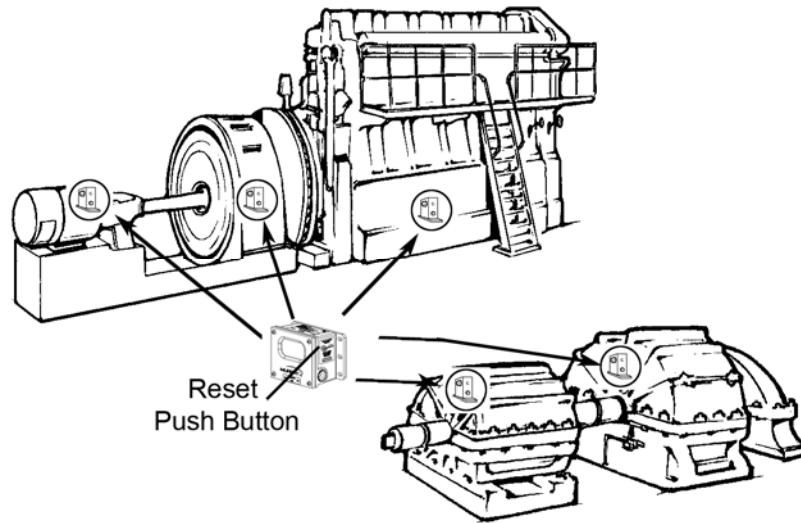
**Figure 6 - Cooling Tower Fan or Heat Exchanger**



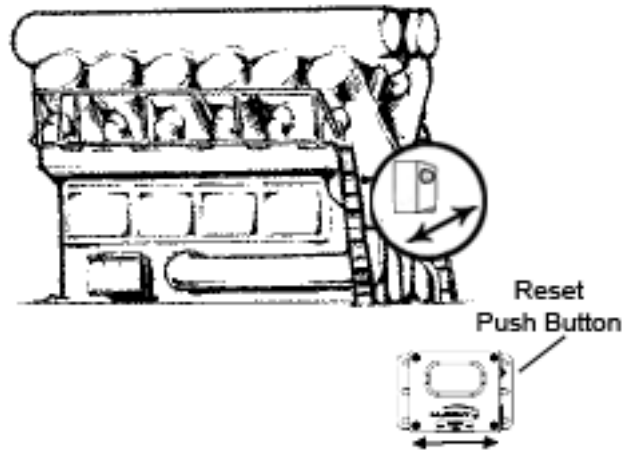
**Figure 7 - Two-Throw Balance-Opposed Compressor**



**Figure 8 - Engine and Vertical Shaft Pump**



**Figure 9 - Generator Sets**



**Figure 10 - Engine Compressor**

## Wiring

---

The method chosen to electrically connect to the switch should be mechanically flexible to eliminate the measurement of vibration induced from conduit and to provide a moisture barrier as well. Although Sealtite™ and other flexible conduit have been used successfully, in areas of extreme humidity or moisture Murphy recommends using an “SO” type cable along with a Div. 2 suitable rain-tight CGB Gland/Strain relief fitting. No stress should be possible on the wiring to the terminal block. If such protection is not provided by the conduit system, some form of stress relief must be installed.

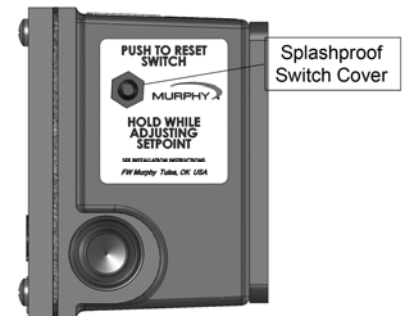
To assure compatibility with EMI compliance standards, any signal level wiring such as transducer, reset, lockout alarm output, or 4-20 mA wiring should utilize shielded cable in EMI proof conduit, separate from any power wiring except the DC power for the EVS.

AWG 16-26 wire can be used. Terminals will accept one AWG 16 conductor or two AWG 20, or four AWG 22 wires can be used per terminal.

## Sealing

It is important that the cover plate, glass and gaskets be evenly and firmly fastened down with the four screws provided. Although the switch enclosures are sealed, it will be ineffective if proper sealing measures of both cover and wiring entrances are not followed. Electrical conduit may conduct moisture.

IMPORTANT! To avoid compromising the weatherproof integrity of the unit, the Weatherproof Boot for the Reset Push Button and the Cover Gasket should be replaced if either becomes torn. Replacement part number 20-00-0378 provides the Weatherproof Boot and Cover Gasket.



IMPORTANT! Do not direct power-washing nozzle at the EVS.

## Electrical Installation

Follow the steps below to wire TB1 and TB2 terminal blocks.

<b>Step 1</b>	Use a slotted, narrow-head screwdriver blade to release the spring cage.	
<b>Step 2</b>	Place the screwdriver blade into the spring cage. (See “Wiring Detail” illustration).	
<b>Step 3</b>	Push the screwdriver straight down into the spring cage until it touches the bottom.	
<b>Step 4</b>	Release the spring cage by pushing the screwdriver away from the wire terminal and holding it in place. (See “TB1 Detail” illustration).	
<b>Step 5</b>	Insert the wire lead into the wire terminal.	
<b>Step 6</b>	Release the tension on the screw driver and remove it from the cage.	
<b>Step 7</b>	Gently pull on the installed wire to make sure the connection is reliable.	

**Figure 11 - Wiring Detail**

**Field Wiring for TB1** (See *Figure 11 - TB1 Detail and Wiring Diagram schematic and Figure 13 – EVS Hook-up*)

<b>Pin 8</b>	Short to Pin-7 or ground for Non-Latching mode	
<b>Pin 7</b>	Common Ground	
<b>Pin 6</b>	Normally Open Alarm Output (closes to ground on fault)	
<b>Pin 5</b>	Normally Closed to ground Alarm Output (opens from ground on fault)	
<b>Pin 4</b>	External Reset Input	
<b>Pin 3</b>	Common Ground	
<b>Pin 2</b>	DC Power 8-32 VDC Positive	
<b>Pin 1</b>	4-20 Current Output (if supplied w/ analog option)	

**Figure 12 – TB1 Wiring Diagram**

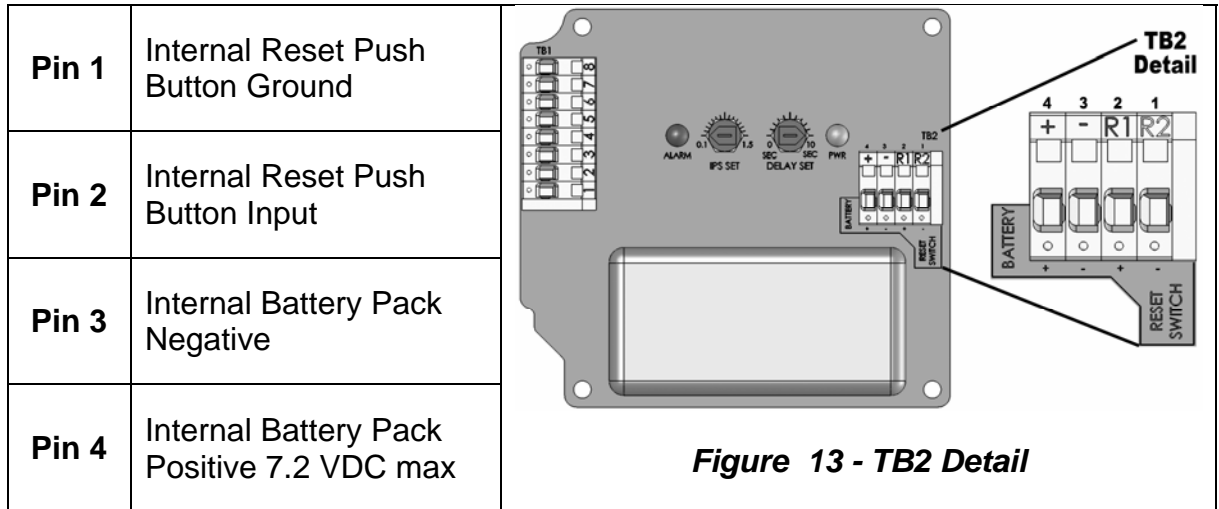


## Field Wiring for TB2

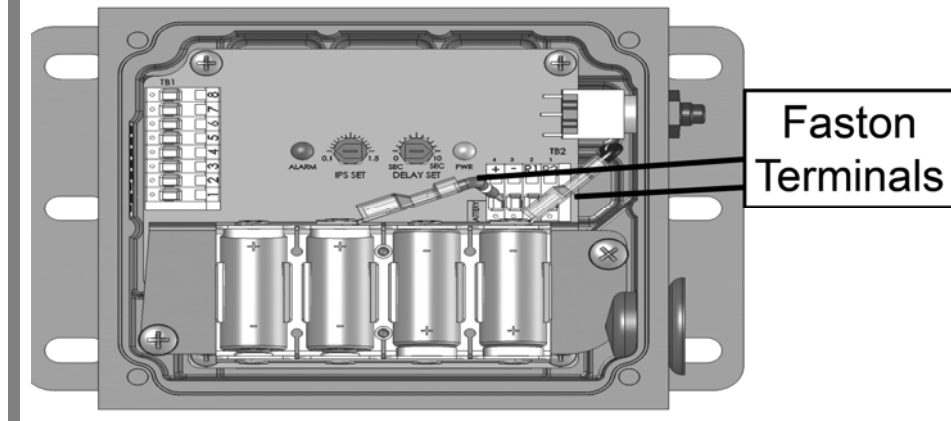


**WARNING! DO NOT CONNECT FIELD WIRING FOR TB1 TO THE TB2 TERMINAL BLOCK.**

The TB2 Terminal Block is intended for wiring the Internal Battery Pack and the Local Reset Switch.

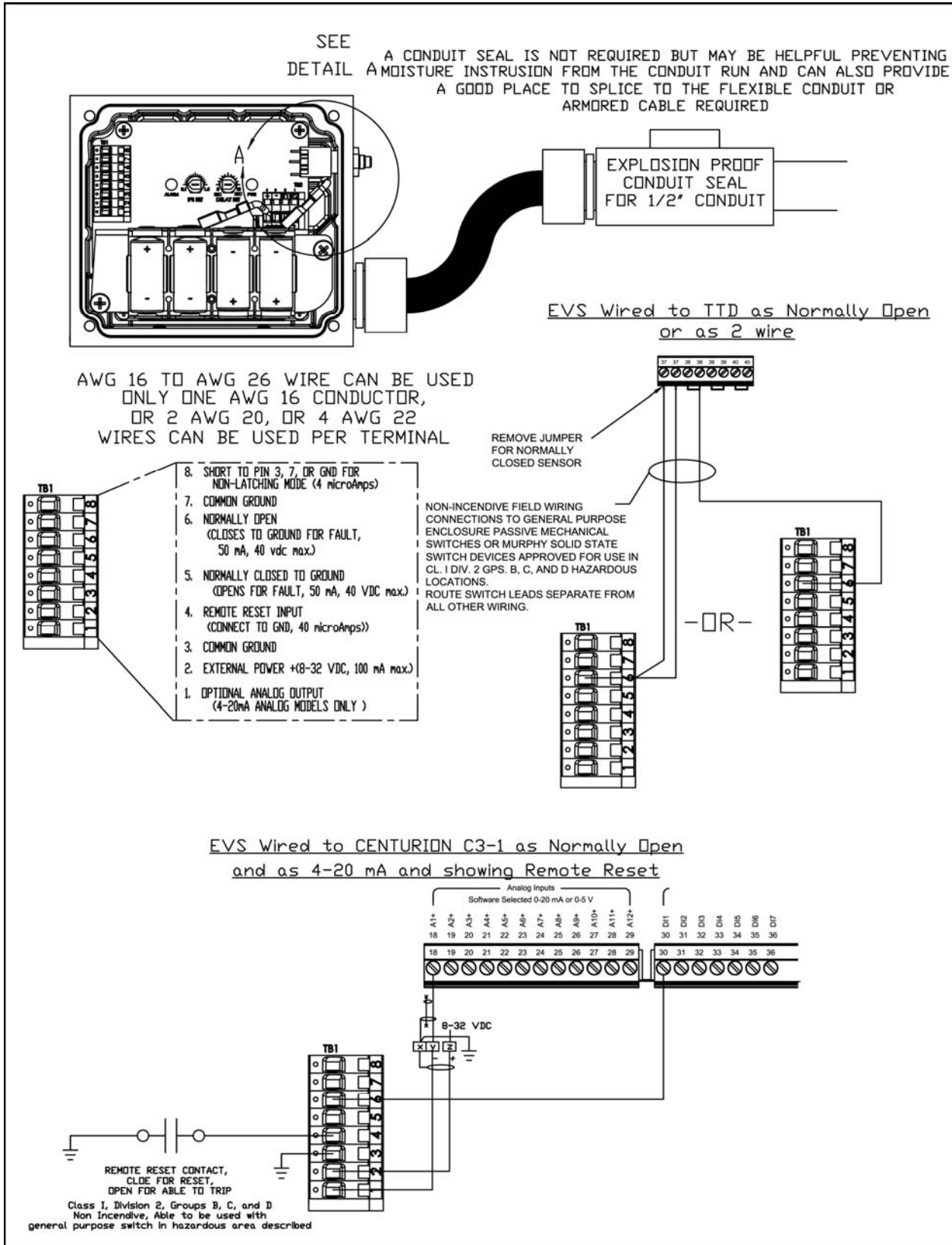


**NOTE:** Once the Battery Pack has been installed and wired, unnecessary tampering may cause the Faston terminal to come loose, resulting in inaccurate analog/switch operation.

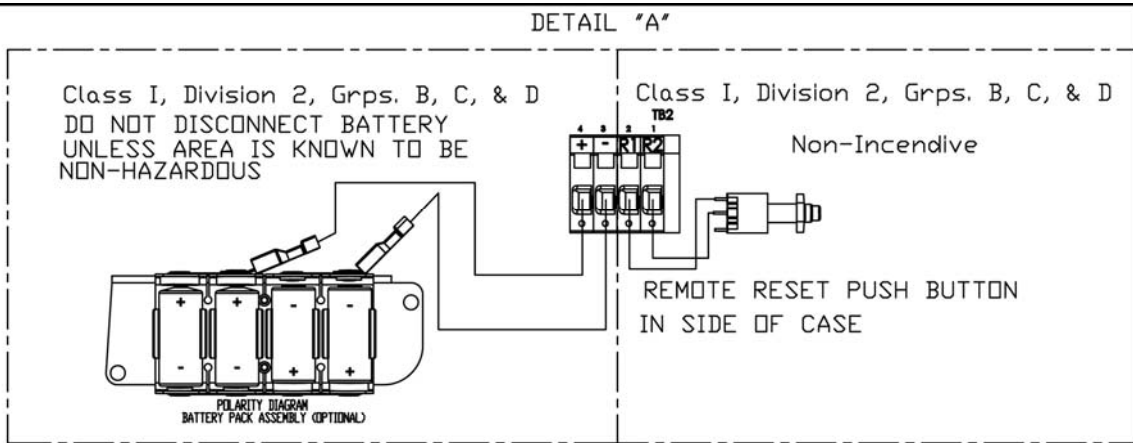


**WARNING! EXPLOSION HAZARD –**  
Do not replace battery unless the area is known to be non-hazardous.  
Use only batteries made specifically for the Murphy EVS.

**Figure 14 - EVS Hook-up**

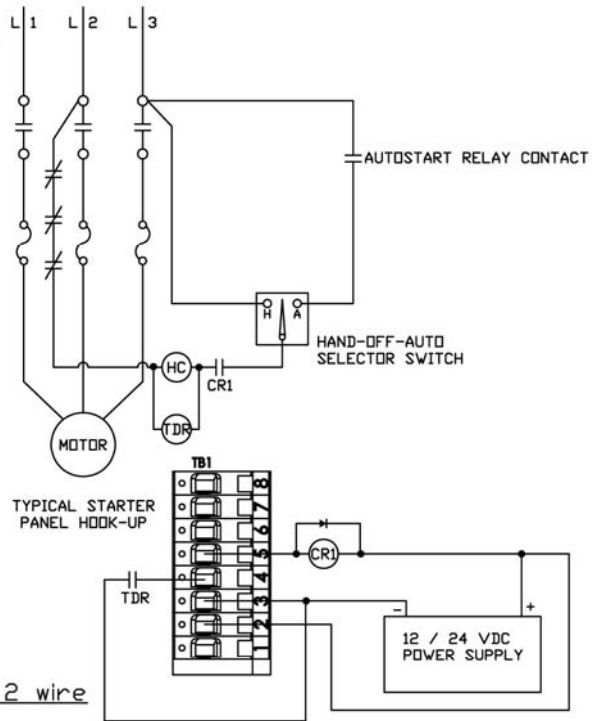
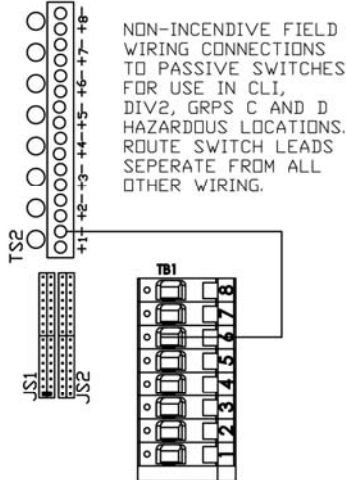


**Figure 14 - EVS Hook-up (continued)**

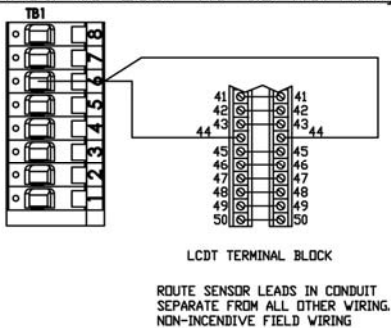


EVS Wired to Electric Motor Starter Panel as Normally Closed and with Delay on Break Time Delay Relay for start-up reset

EVS Wired to MCPS DI as Normally Open



EVS Wired to LCDT-NC as Normally Open 2 wire

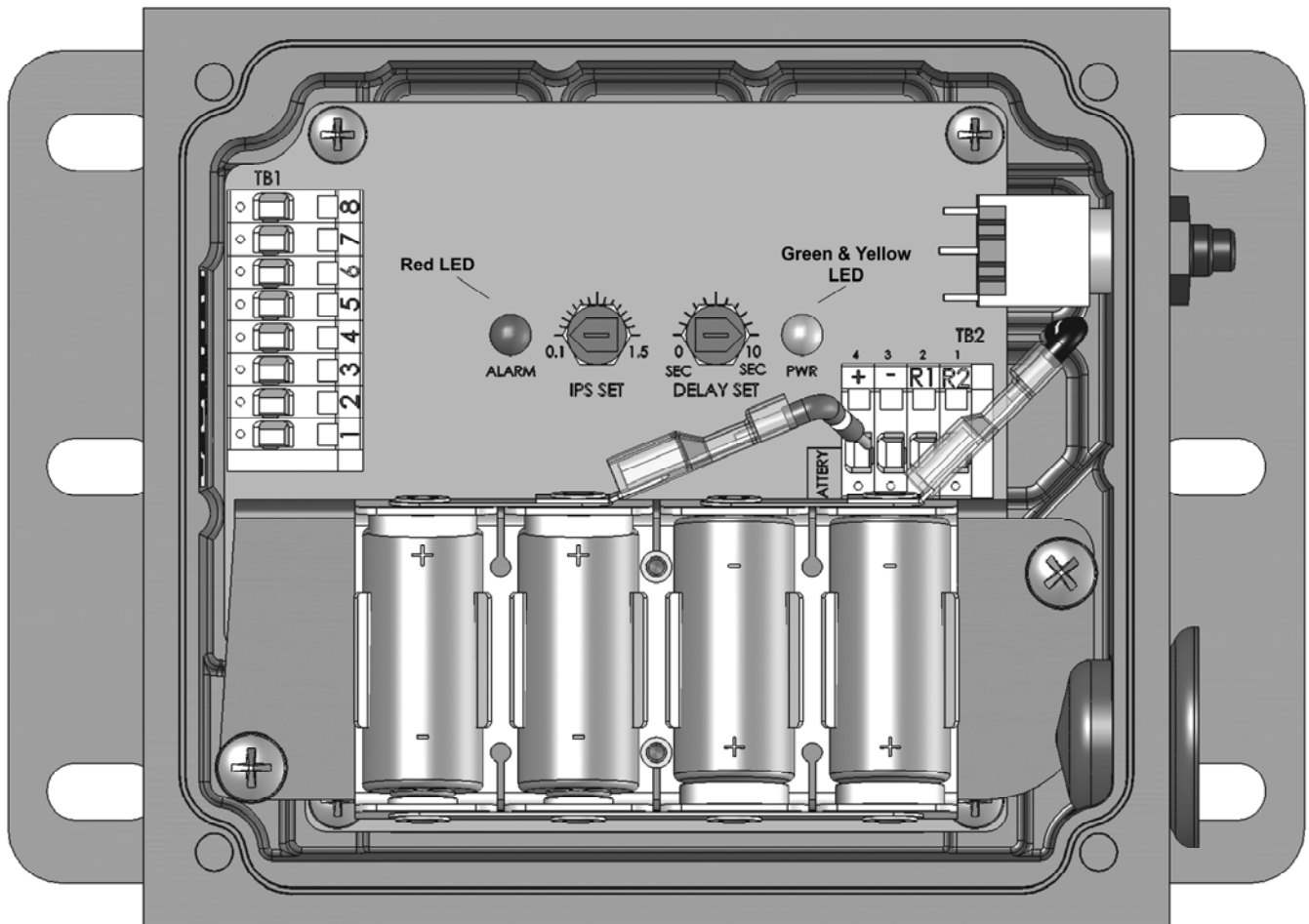


A CHANGED TERM 7 FUNCTION		3/24/06			
REV/CHANGES MADE	DATE:	SCALE:	DATE	ERNO	BY
TOLERANCES UNLESS NOTED OTHERWISE .XX ± .030 ANGLES ± 2° .XXX ± .010 ✓ 125	DRIGER#	CHKD BY:			
FINISH	DRWN BY:	APPD BY:			
Dwg. SIZE <input type="checkbox"/> PRE-PROD. <input type="checkbox"/> PROD. <input type="checkbox"/>		NAME EVS Hook-Up Drawing		DRAWING NO. 20-08-xxxx	
MATERIAL		REV A			

## Settings

### Setting the Set-point in Inches Per Second (IPS) Peak

**NOTE:** The unit must be set per the application upon installation.



**Figure 15 – EVS Detail for setting IPS and Delay Set-points**

## Method 1

Refer to the monitored machine recommended setting and mounting information and make appropriate adjustments. To adjust the setpoint, open the Murphy EVS cover and follow these steps:

1. Use a slotted, narrow-head screwdriver to adjust the IPS SET potentiometer.
2. To increase the IPS setting, turn the IPS SET potentiometer clock-wise. Tick marks in the EVS indicate 0.1 to 1.5 IPS range in 0.1 IPS increments.
3. To decrease the IPS setting, turn the IPS SET potentiometer counter clockwise.
4. Set the Delay (0-10 seconds, one tick mark per second) according to the tick marks in the EVS.

## Method 2

When placing the Murphy EVS on a unit where no available instruments or systems identify exactly what the actual vibration of a unit is in IPS Peak, use the following method to customize the setting to the installation, after determining the switch is functioning properly. (Note: This can be performed in Latch or Non-Latching modes.)

1. Make sure that the machine to be monitored is powered on and in normal operation.
2. Press and continue to hold the Local Reset button, located on the right hand side of the Murphy EVS. In this mode the output contact will not change status, only the alarm LED will light.
3. Using a slotted head, screw driver turn the "DELAY SET" potentiometer to zero.
4. Slowly turn the "IPS SET" potentiometer counterclockwise until the "Alarm LED" comes on.
5. Slowly turn the "IPS SET" potentiometer clockwise until the "Alarm LED" goes off.
6. Now turn the "IPS SET" potentiometer 1 or 2 tenths of an IPS higher than the observed trip point.
7. Release the Reset push button.

## Determining & Adjusting The Delay Set-point

The Delay Setpoint value can define the line between sensitivity and nuisance faults. A low delay allows a potentially catastrophic failure to be detected quickly. A higher delay helps prevent normal start-up vibrations from triggering an alarm. An evaluation of these two conditions should be made for each unique installation before setting the Delay Setpoint.

If start-up vibrations trigger the alarm at the desired delay set-point, the unit can be configured for an unlatched output and wired to a "Class B" input timer on a Murphy annunciator or controller. If used with a PLC system, the input can be timed out for startup. With the reset input active (pushbutton depressed) the Alarm LED will activate, but the alarm outputs will not change to the alarm state. If the reset pushbutton is released while the unit is in an alarm state, the unit will shut down if that input is active on the annunciator.

Optionally, a controller output can be used to hold the EVS in remote reset during startup.

To adjust the delay set-point follow these steps:

1. Use a slotted, narrow-head screwdriver to adjust the DELAY SET potentiometer.
2. To increase the delay setting, turn the potentiometer clockwise. Tick marks in the EVS indicate 0 to 10 second range in one (1) second increments.
3. To decrease the delay setting, turn the potentiometer counter clockwise.

## Useful Vibration Formulas

$V = \pi f D$	$g = 386.1 \text{ inches / second}^2$
$V = 6.144 \text{ g/f}$	$D = \text{inches peak-to-peak}$
$g = 0.0511 \text{ f}^2 D$	$f = \text{RPM}/60$
$g = 0.0162 \text{ V/f}$	$\text{rms} = 0.707 \times \text{peak}$
$D = 0.3183 \text{ V/f}$	$\text{peak-to-peak} = 2 \times \text{peak}$
$D = 19.57 \text{ g/f}^2$	$\pi = 3.1416$
$V = \text{inches / second}$	

## Setting of Alarms

---

The alarm values may vary considerably, up or down, for different machines. The values chosen will normally be set relative to a baseline value determined from experience for the measurement position or direction for that particular machine.

In the following chart, it is recommended that the alarm value should be set higher than the baseline by an amount equal to 25% of the upper limit for Zone B. If the baseline is low, the alarm should be below Zone C.

Where there is no established baseline (for example with a new machine) the initial alarm setting should be based either on experience with other similar machines or relative to agreed acceptance values.





After a period of time, the steady-state baseline value will be established and the alarm setting should be adjusted accordingly.

## Recommended Alarm Settings




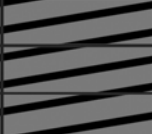
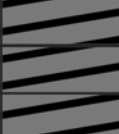


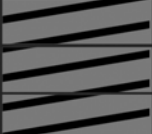

















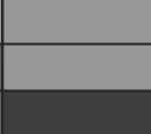



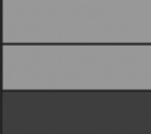


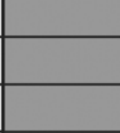
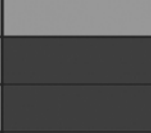

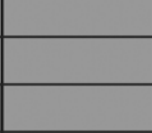
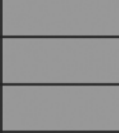
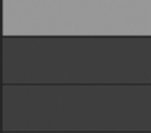

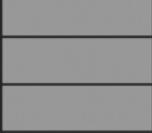
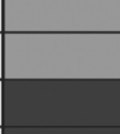
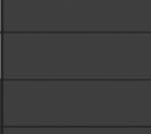
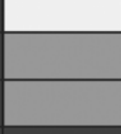
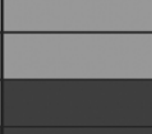
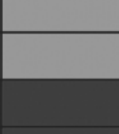
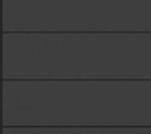
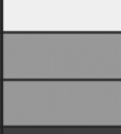
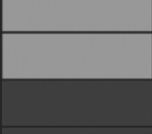
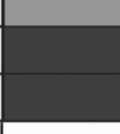
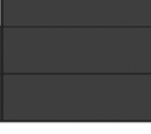
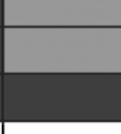
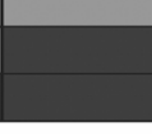
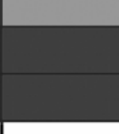
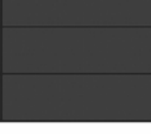
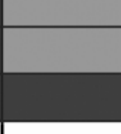
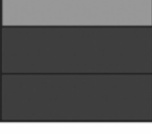
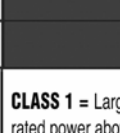
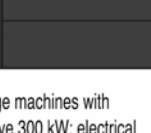
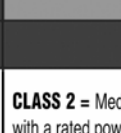
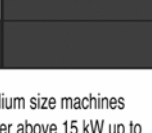
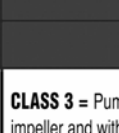
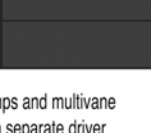
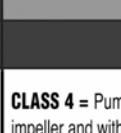
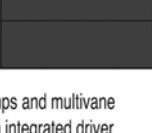
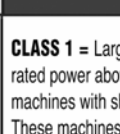
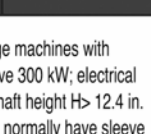
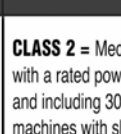
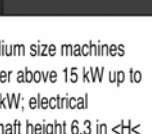
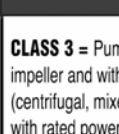
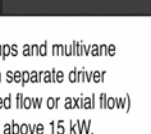
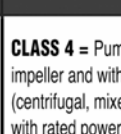
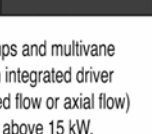
The following are guidelines based on industry standards. Actual settings will vary depending on mounting and unit installation. (Note: Refer to the Appendix for recommended settings by specific manufacturers.) Experience with a given installation should be the major factor in deciding the settings.

It is recommended that the alarm value should not normally exceed 1.25 times the upper limit of zone B.

## Vibration Limits Based on Class of Equipment Based on ISO 10816-3

	<b>ZONE A</b> = Newly commissioned machines normally fall into this zone.
	<b>ZONE B</b> = Normally considered acceptable for unrestricted long-term operation.
	<b>ZONE C</b> = Normally considered unsatisfactory for long-term continuous operation.
	<b>ZONE D</b> = Normally considered to be of sufficient severity to cause damage to the machine.

**RIGID/FLEXIBLE** = Categorizes the type of support and mounting.

Vibration ips RMS	CLASS 1		CLASS 2		CLASS 3		CLASS 4		Vibration ips Peak
	RIGID	FLEXIBLE	RIGID	FLEXIBLE	RIGID	FLEXIBLE	RIGID	FLEXIBLE	
0.58									0.82
0.43									0.61
0.28									0.40
0.18									0.25
0.14									0.20
0.11									0.16
0.09									0.13
0.06									0.08
0.03									0.04
<p><b>CLASS 1</b> = Large machines with rated power above 300 kW; electrical machines with shaft height H &gt; 12.4 in. These machines normally have sleeve bearings. the range of operation or nominal speed is relatively broad and ranges from 120 rpm to 15,000 rpm.</p>		<p><b>CLASS 2</b> = Medium size machines with a rated power above 15 kW up to and including 30kW; electrical machines with shaft height 6.3 in &lt;H&lt; 12.4 in. These machines normally have rolling element bearings and operation speeds above 600 rpm.</p>		<p><b>CLASS 3</b> = Pumps and multivane impeller and with separate driver (centrifugal, mixed flow or axial flow) with rated power above 15 kW. Machines of this group mostly have sleeve or rolling element bearings.</p>		<p><b>CLASS 4</b> = Pumps and multivane impeller and with integrated driver (centrifugal, mixed flow or axial flow) with rated power above 15 kW. Machines of this group mostly have sleeve or rolling element bearings.</p>			

## Typical Vibration Alarm Settings of Various Installations

**THE VALUES LISTED BELOW ARE GUIDELINES ONLY** – Actual vibration limits must be related to stress levels, which can be measured with strain gage equipment. In general, if vibration levels are below the guidelines mentioned below, the stress levels are well below the fatigue level of the equipment. If vibration problem is perceived, a spectral analysis should be performed on the unit by a qualified specialist.

Type of Equipment	Velocity (IPS peak)	
	LOW	HIGH
Compressor, Centrifugal	0.2	0.4
Compressor, Reciprocating	0.5	0.7
Conveyors	0.3	0.5
Electric Motors	0.1	0.3
Engines	0.5	0.7
Fans, Blowers	0.2	0.4
Gear Boxes	0.1	0.3
Generator Sets, Electric Driven	0.2	0.3
Generator Sets, Engine Driven	0.5	0.7
Machine Tools (unloaded)	0.05	0.2
Pumps, Centrifugal	0.1	0.3
Pumps, Gear	0.1	0.3
Pumps, Reciprocating	0.5	0.7
Turbines	0.05	0.2

## Reciprocating Compressor Vibration Setting Guidelines

**THE VALUES LISTED BELOW ARE GUIDELINES ONLY** – Cyclical failures generally occur in the range of 10 to 100 cycles. High velocity at high frequency will result in failure at a much greater rate than high velocities at a low frequency. Experience should also be a guideline in determining acceptance limits for a particular compressor package.

Type of Equipment	Velocity (IPS peak)	
	(ips)	(mm/sec)
Motor Frame	0.3 – 0.5	8 – 12
Compressor Frame	0.2 – 0.3	5 – 8
Compressor Cylinder (outer end)	0.5 – 1.0	12 – 25
Pulsation bottles (outer center)	0.5 – 1.0	12 – 25
Skid Frame (top)	0.1 – 0.3	2.5 – 8
Scrubber (6'-6" elevation)	0.8 – 1.0	20 – 25
Piping (saddles and 12" spans)	0.5 – 0.8	12 – 20
PSV's (top of valves)	0.6 – 0.8	15 - 20



## **Equipment Manufacturer Recommended Settings**

---

### **ARIEL: SKID, FRAMES, CYLINDERS (provided by Ariel) MICROLOG CMVA60**

**SETUP:** Velocity ins/sec, zero to peak

If a vibration problem is perceived, a spectral analysis should be performed on the unit by a qualified vibration specialist.

The following chart indicates overall average limits for various models of Ariel equipment. **THESE VALUES ARE GUIDELINES ONLY** - Actual vibration limits must be related to stress levels, which can be measured with strain gage equipment. In general, if vibration levels are below the guidelines mentioned below, the stress levels are well below the fatigue level of the equipment.

<b>Model</b>	<b>JG, A, M, N, P, Q, R, W</b>	<b>JGJ, H, E, T, K</b>	<b>JGC, D, B, V</b>
Skid	<0.10 IPS	<0.15 IPS	<0.20 IPS
Compressor Frame	<0.20 IPS	<0.40 IPS	<0.20 IPS
Compressor Cylinder	<0.45 IPS	<0.80 IPS	<1.0 IPS

Chart effective 10/01/00, Check latest limits on Ariel Web Site.

Other manufacturer's data will be provided as authorized.

## Specifications

### Environmental

---

- Temperature: -40° and +85°C.
- Humidity: 0-95% non-condensing
- Vibration: 30 g's (Mechanical stability)

### External DC Power Requirement

---

- External power: 8 - 32 VDC.
- Input Current: 100mA Max

### Sensor Accuracy / Noise

---

- $\pm 5\%$  of full scale at 1.5 ips and 21 deg C.
- $\pm 5\%$  Variation over temperature from 21 deg C.
- Integration Stage End-to-End Noise: <0.01 ips RMS
- $\pm 5\%$ , at Bandwidth of 6 to 500 Hz
- $\pm 3\text{dB}$  at Bandwidth of 3 to 850 Hz, worst case

### Trigger Level Feature

---

- Adjustable single turn potentiometer between 0.1 and 1.5 inches per second (ips) Peak, in 0.1 increments.

### Time Delay Feature

---

- Adjustable single turn potentiometer from 0 to 10 seconds in 1 second intervals

### Output

---

- Normally-Open (close to ground) on fault
- Open-collector outputs
- 50 mA sink capability
- Input voltage: 40 VDC maximum
- Output is supplied latched. Provision is incorporated for non-latch operation. Reset accomplished by reset pushbutton or external contact closure.
- Output circuits based on fault sensitive operation. Alarm activated on power loss.

## **LED Outputs**

---

- Red LED Alarm output: Flashes twice per second for the first 5 minutes when in Alarm mode. After 5 minutes it will flash once every second until reset.
- Green/Amber LED Power output: Green flash every 6 seconds: Battery status 'Normal'.
- Amber flash every 6 seconds: Battery in 'Low-Battery' range.

## **4-20mA output (option)**

---

- Loop Resistance: 600 ohms max at 24 V and 20mA.
- Current loop accuracy  $\pm 5\%$ .
- 20 ma corresponds to 1.5 ips Peak
- 4 ma corresponds to 0 ips Peak

## **Reset**

---

- Local reset switch w/momentary contact mounted to enclosure and connected to EVS PCB by means of a two wire connector TB2.
- Non-Incendive circuits for local Push Button and remote contact input
- External reset: Requires an external dry contact to activate the reset.
- Activation Period: Reset must be active for 0.5 sec. minimum to reset EVS

## **Approvals (applied for)**

---

- Class 1 Div 2 Hazardous Area, Groups B,C,D.

**(THIS PAGE INTENTIONALLY LEFT BLANK)**

MURPHY, the Murphy logo, TTD™, Centurion™ or Millennium™ and VS2™ are registered and/or common law trademarks of Murphy Industries, Inc. This document, including textual matter and illustrations, is copyright protected by Murphy Industries, Inc., with all rights reserved. (c) 2005 Murphy Industries, Inc. Other third party product or trade names referenced herein are the property of their respective owners and are used for identification purposes only.



[www.fwmurphy.com](http://www.fwmurphy.com)

(918) 317-4100

[sales@fwmurphy.com](mailto:sales@fwmurphy.com)